

ILIFE

User Manual

Robotic vacuum cleaner

Model: V5s Plus

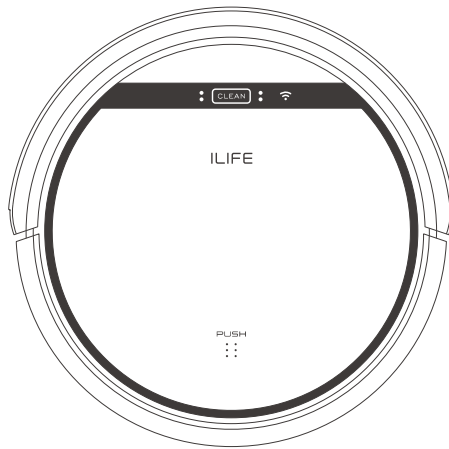

English

Español

www.iliferobot.com

Dear Customer,

Thank you for purchasing ILIFE V5s Plus robotic vacuum cleaner! You've joined the millions of people who clean with robots - the smarter way to get it done.

Please take a few moments to read this manual and get acquainted with your robot, to get the best performance from your robot. If you have any problems with your robot please do not hesitate to contact our customer service or visit our website at www.iliferobot.com for more information.

Stay connected with us on Facebook and twitter to enjoy these exclusive benefits:

- Get support tailored to your specific robot, including answers to questions, maintenance tips, video demos, live chat and more.
- Get product updates and other valuable information among the first to find out about new robots, exclusive discounts and special promotions.

Connect with us right now at
Facebook: facebook.com/iliferobotics
Twitter: twitter.com/ILIFEROBOTICS

Enjoy a thorough cleaning every day!
Best regards,
ILIFE Innovation

ILIFE Customer Service



1-800-631-9676 (Toll free for North America)

Mon-Fri: 8:00 A.M. - 7:00 P.M. CST



service_us_ca@iliferobot.com

Important Tips

How to use

- Before using the robot, please ensure the power switch is on. Take a few moments to survey the area to be cleaned and remove any obstacles.
- The robot will pass over the same area of the floor multiple times to ensure thoroughly clean.
- The spinning brushes may flick small granule (dog food, cat litter) here and there, but finally the robot will vacuum them all in.
- Before replacing side brushes, check and match "L" "R" mark on both side brush and bottom of robot.
- When you set the clock time or schedule, the final operation will be confirmed by beep from robot. If no tone received, your setting is unsuccessful.
- Empty the dustbin. You could notice the robot vacuum less, even spits out, when the dustbin is full, though there is no any warning beep sound.

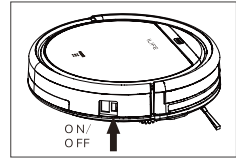

For best performance

- Empty V5s Plus's dustbin and clean its filter after every use.
- Filter could not be washed by water.
- Replace new Filter when you notice V5s Plus vacuum gets weaker and pick up less than before.
- Put charging dock against the wall and remove obstacles about 1 meter at two sides and about 2 meters forward.
- Fully charge robot's battery before each cleaning cycle.

Battery life

To extend V5s Plus's battery life and keep its cleaning at peak performance:

- Charge the robot overnight before first time use.
- If the robot is not used for a long time, please turn off the power switch.
- Recharge the robot as soon as possible. Waiting several days to recharge may damage the battery.
- Use the robot frequently.

Warning: The product contains electronic parts. DO NOT submerge V5s Plus or spray it with water, clean with a dry cloth only.

Contents

Safety Instructions	4
Product Composition	6
List of accessories	6
Robot anatomy	7
Dustbin	8
Charging dock	8
Water tank	8
Remote control	9
CLEAN button status	9
Remote control operating	10
Notice for Use	12
How to get started	12
Starting up/Pause/Sleeping	14
Scheduling	15
Cleaning mode	16
Wet mopping	17
APP Download	18
Maintenance	19
Cleaning side brushes	19
Cleaning dustbin and filter	19
Cleaning cliff sensors and auto charging pins	20
Nose wheel clean up	20
Trouble Shooting	21
Error code sheet	21
Error appearance	22
Product Specifications	24

Safety Instructions

Before using this product, please read the following safety instructions and follow all normal safety precautions.

- Read this user manual thoroughly and carefully before using this product.
- Keep this user manual.
- Any operation or use of this product in any way other than that described in this manual may lead to serious injury or product damage.

WARNING

1. Only certified technicians may disassemble the product. Users are not allowed to disassemble or repair the product.
2. Only use the AC adapter provided by the factory. Using other AC adapters may cause electric shock, fire or product damage.
3. Do not touch the power cord, plug or adapter when your hands are wet.
4. Keep loose clothing and fingers away from being drawn into the product's wheels.
5. Keep the robot vacuum away from all flammables.
6. Never clean the robot while it is on the charging dock or plugged in directly. Unplug the robot and turn off power switch when cleaning.
7. Keep the AC power cord tucked away from becoming damaged in any way.
8. This product is to be used only indoors. Not intended for outdoor use.
9. Do not sit on top of the product or attach an object on the top of it.
10. Do not use this product in wet or moist environments.
11. Before use, remove all the objects that could get caught in the brushes or suction passage.
12. Do not place this product on furniture or platforms where it can fall and be damaged.
13. Turn the power switch off when not in use for a long period of time or when transporting the unit.
14. To avoid battery damage please check whether adapter and outlet are properly connected.

Safety Instructions

15. To avoid any tripping hazards or injuries please inform all the people in the house when this product is in use.
16. Do not use this product when dustbin is full.
17. Do not operate this product in high temperature environments.
18. The battery must be removed from the product before it is scrapped.
19. Unplug the vacuum from power source when removing the battery.
20. The battery is to be disposed of safely.
21. Use factory authorized battery only. Do not use unmatched battery.



Note:

This product is not a toy and should not be used by children or people with the lack of related experience or knowledge.

Product Composition

List of accessories

Serial number	Description	Q'ty
1	Main body (battery included)	1
2	Charging dock	1
3	Remote control (battery not included)	1
4	AC adapter	1
5	Cleaning tool	1
6	User manual	1
7	Extra side brushes	2
8	High performance filter	2
9	Mop cloth	1
10	Water tank	1

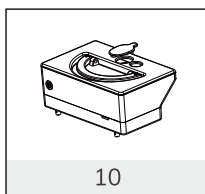
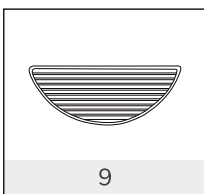
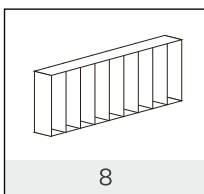
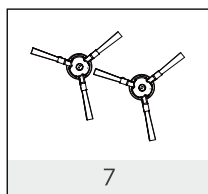
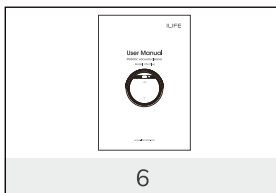
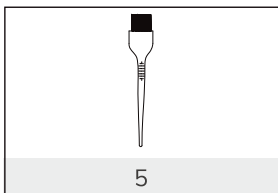
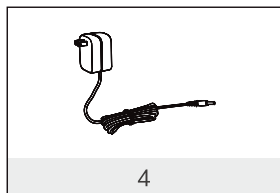
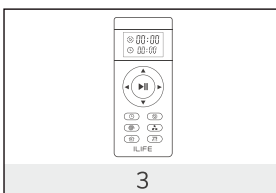
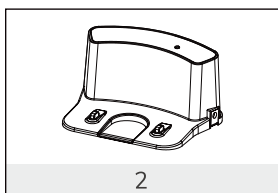
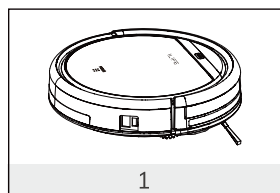

Product Composition

Robot anatomy

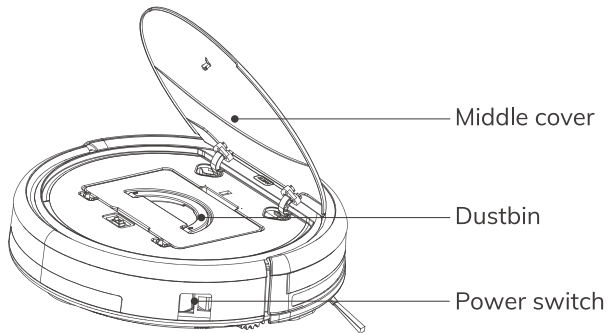
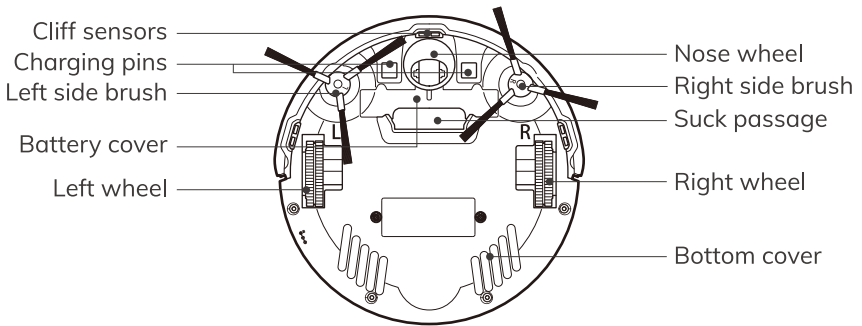
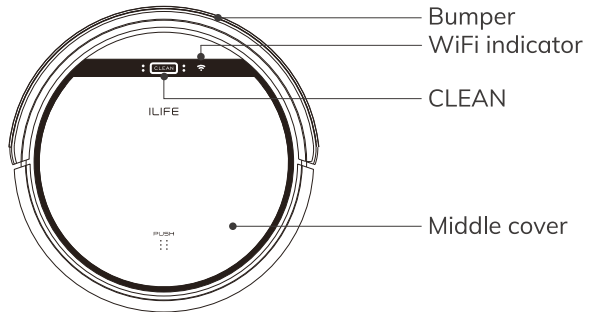

Product Composition

Dustbin

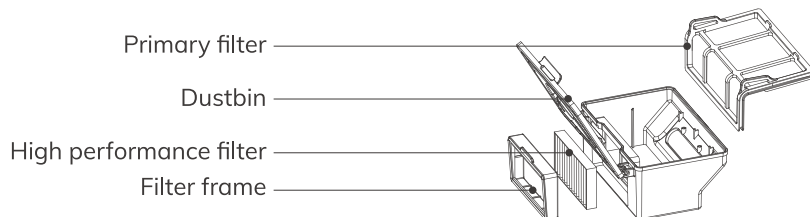

Charging dock

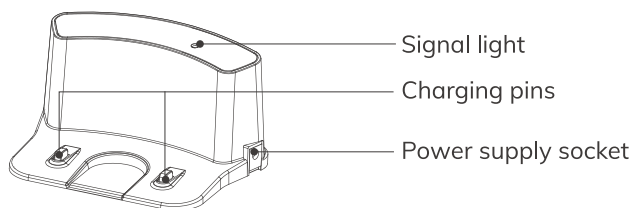

Water tank

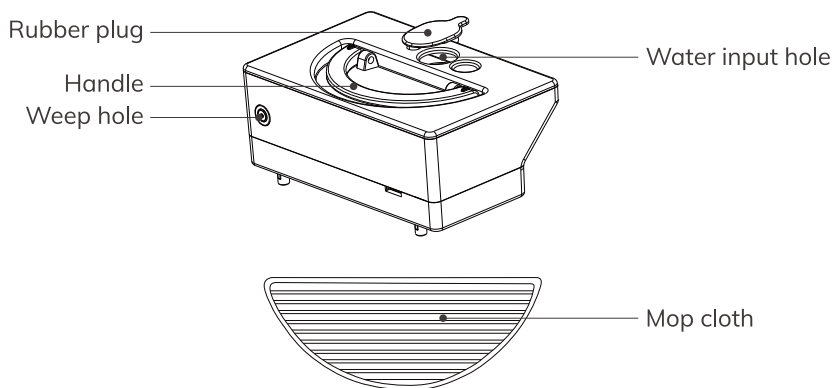

Product Composition

Remote control

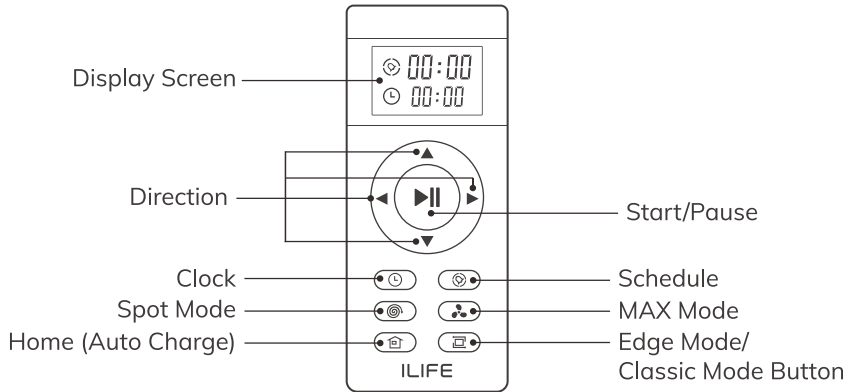

CLEAN button status

Robot status	Light status
Charging	All lights flash gradually
Charging finished	All lights turn off
In selected mode	All lights flash slowly
When robot in error	All lights flash
Low battery	Middle lights flash
In home mode	Middle lights flash slowly
In cleaning mode	Middle lights turn solid
In edge mode	Middle lights turn solid, lower lights flash
In spot mode	Middle lights turn solid, upper lights flash
Distribution mode	WiFi indicator flashes
Distribution network success	WiFi indicator is constantly on

Product Composition

Remote control operating

1. “▶” Starting up/Pause

- Press this button to start cleaning in selected mode.
- Press this button to make the robot stop when it's cleaning.
- Press this button to exchange from sleeping mode to selected mode.

2. Directional buttons

A. “▲” button:

- Press this button to increase number in scheduling or clock mode;
- Press this button to make robot move forward in selected mode and the robot will stop when it hits any objects.

B. “▼” button:

- Press this button to decrease number in scheduling or clock mode.

C. “◀” button:

- Press this button to exchange from minute to hour in scheduling or clock mode.
- Press this button to make robot turn left.

D. “▶” button:

- Press this button to exchange from hour to minute in scheduling or clock mode.
- Press this button to make robot turn right.

3. “⊞” Plan button

- Press this button to enter scheduling mode when in selected mode or charging mode.
- Press this button to confirm scheduling in scheduling mode.

4. “⌚” Clock button

- Press this button to enter clock mode when in selected mode or charging mode.
- Press this button to confirm clock setting in clock mode.

Product Composition

5. “” Auto charge button

When robot is in selected mode or cleaning mode, Press this button to return robot to charging dock.

6. “” Edge button

Press this button to make robot clean along wall.

7. “” Spot button

Press this button to make robot start spot cleaning.

8. “” Max

To maximize vacuuming power.

9.  : :  Shows the scheduling time.

10.  :  Shows the clock time.



Note:

1. Install two AAA type batteries into the remote control.
2. Take out the batteries if the remote control is not used for long time.

Notice for Use

How to get started

1. Place charging dock, plug in adapter, signal light on charging dock will turn solid.

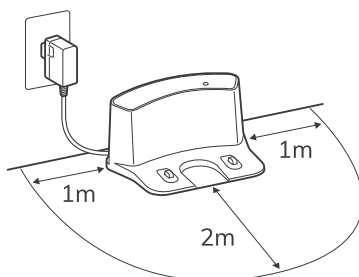

Note: put charging dock against the wall and remove obstacles about 1 meter at two sides and about 2 meters forward.

2. Turn on the power switch around power socket, then display panel will flash.

(If no command received, the robot will turn to sleeping mode after 15 seconds.)



Note:

- A. Please always keep the power switch turning on. If not, it is unable to make the robot work.
- B. If power switch is turned off, all the scheduling will be lost.



Caution:

Before charge the robot, please make sure the power switch is turned on, or else the robot can not be charged.

Notice for Use

3. Charge the robot in either way as shown below:

- A. Plug into an outlet.
- B. Press  to make robot return to charging dock for charging itself.

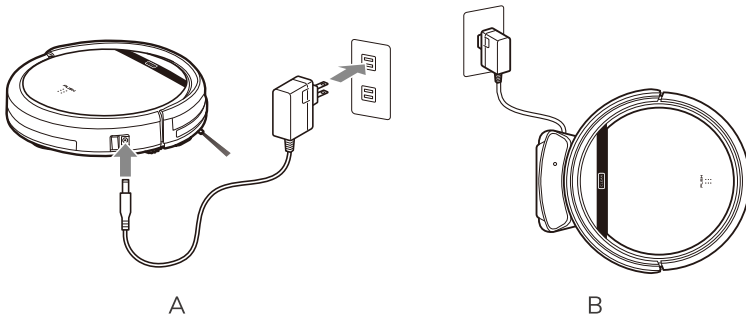

For better extending battery life:

- A. Before first use, charge the robot overnight. When charging is finished, display panel will turn off.
- B. In normal use, always store the robot on charging dock with base plugged in.
- C. If the robot is not used for long time, turn the power switch off, fully charge the robot and store it in a cool, dry place.

4. Auto charging

The robot will automatically return to charging dock when battery is low.

Notice for Use

Starting up/Pause/Sleeping

Sleeping mode: robot is not working, lights around CLEAN button are off and power switch is on.

Selected mode: robot is not working, lights around CLEAN button flash.

Cleaning mode: robot is working, lights around CLEAN button are on. Please refer to the form on the page 9.

1. Starting up

A. Make sure the power switch is on.

B. Press CLEAN button on main body or on remote control to start cleaning.



Note:

If robot is in sleeping mode, press CLEAN button to wake the robot up from sleeping mode. Then press CLEAN for a second time, the robot starts cleaning automatically.

2. Pause

Press CLEAN button on main body or on remote control to exchange robot from cleaning mode to selected mode.



Note: When robot is paused, press CLEAN to make robot to re-start cleaning.

3. Sleeping

To turn robot into sleeping mode from selected mode:

A. Keep pressing CLEAN on main body for 3 seconds.

B. Robot will automatically enter sleeping mode if no command received for 15 seconds.

Notice for Use

Scheduling

You can schedule to let the robot start cleaning from a certain time.



Note:

Remember to set the clock time and schedule once replace the remote control battery. Once the clock time is set, any scheduling you have set will make robot work on the scheduled time.

Setting the clock time

1. Point the remote control towards the robot (ensure the power switch is on).
2. Press and then use directional buttons to set the correct time.
3. Press to save the setting. To cancel the schedule, please turn off the robot.

Setting a schedule

The robot will always work at the scheduled time unless power switch of the robot is turned off.

1. Point the remote towards the robot.
2. Press and then use directional buttons to set the schedule.
3. Press to save the setting. To cancel the schedule, please turn off the robot.



Note:

When you set the clock time or schedule, the final operation will be confirmed by beep from robot; If no tone received, your setting is unsuccessful.

Notice for Use

Cleaning mode

1. Auto cleaning

The robot will clean a room automatically and adjust its cleaning according to the situation.



Note:

Press CLEAN button on robot or on remote control to start auto cleaning.

2. Spot cleaning

- A. Press spot on the remote toward the robot when the robot is working.
The robot will circle around and turn into auto clean mode after spot clean is finished.
- B. Press spot on the remote toward the robot when the robot is in selected mode and the robot will begin to circle around. The robot will turn into selected mode after spot clean is finished.

3. Edge cleaning

Put the robot near the edge (wall) and press  on remote control to start edge cleaning.

Notice for Use

Wet mopping

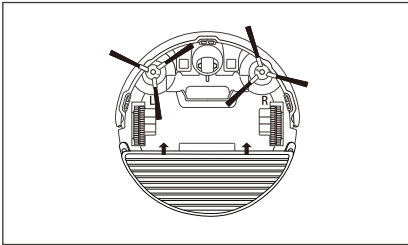

Figure 1

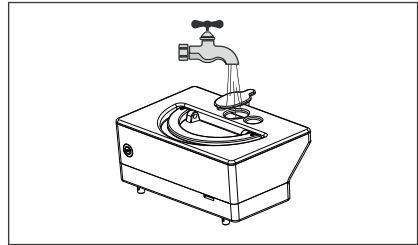

Figure 2

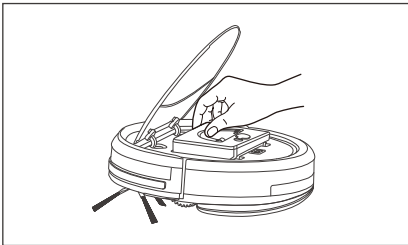

Figure 3

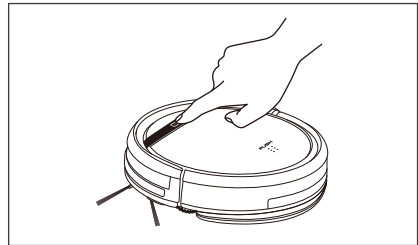

Figure 4

1. Dustbin is for dry clean and water tank is for wet clean.
2. The mop bracket with mop should be on the robot when the water tank is used. (Figure 1)
3. Pouring the clean water into the water tank. (Figure 2)
4. Open the robot lid and put the water tank into the body, the weep hole of the water tank should be aligned with the weep hole on the robot body. (Figure 3)
5. Close the robot lid, press CLEAN button to start the wet cleaning, There is no vacuum suction function during the wet cleaning. (Figure 4)
6. It is suggest to make the suction (dry clean) before wet clean for a better cleaning result.
7. The water in the water tank is flow out automatically. so it is prohibited to let water tank be still inside or outside of the robot when there is still water in the tank. This will cause the water logging on floor.
8. Please take out the water tank when you charge the robot vacuum cleaner.

APP Download

Downloading the App

The robot can be controlled by the “ILIFEHOME” app. Scan the QR code to install the app on your iOS or Android device.



Maintenance

Cleaning side brushes

Clean the side brushes when it gets dirty and replace if it's are damaged.



Note: Before replacing side brushes, check and match "L" "R" marks on both and bottom of robot.

Cleaning dustbin and filter

Clean and empty dustbin after each use, steps are as shown in below figures.

- After taking dustbin, check whether there is foreign matter stuck in suck passage and clean it.
- Clean Filter after 15-30 days' use. And replace it after use for 6 months at maximum.
- Install both Filter and primary filters when they are dry.
- Filter and primary filter could be replaced if needed.

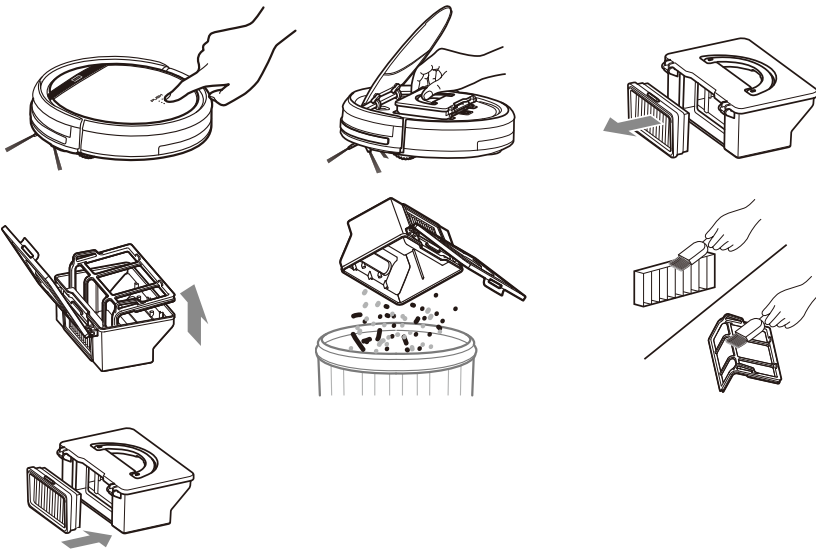

Maintenance

Cleaning cliff sensors and auto charging pins

Slightly clean the sensor window and auto charging pins with a soft dry cloth.



Note: Charging pins on charging dock need to clean if dirty.

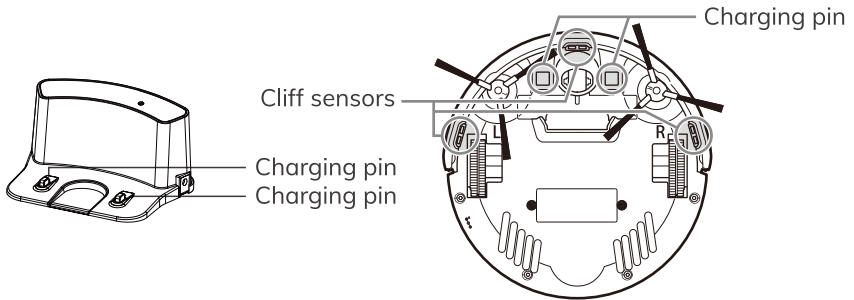

Nose wheel clean up

When there is foreign matter in nose wheel, it will affect the cleaning performance, please clean it follow the way below:

1. Pull the wheel up vertically and clean it. Please note whether the gasket is off.
2. It should be noted that whether the gasket is installed well after clean the nose wheel.

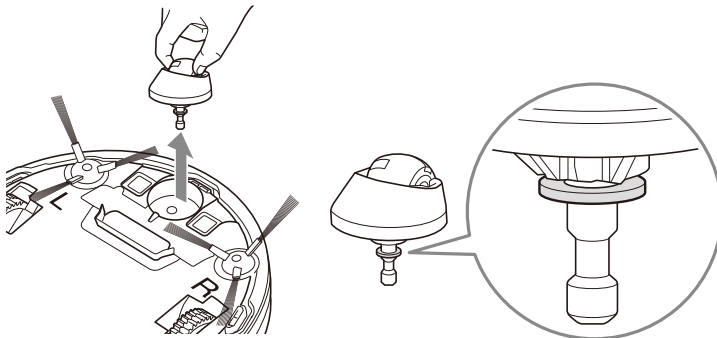

Trouble Shooting

Error code sheet

When the robot meets with some routine troubles, it will remind you by beep.

- Short tone

NO.	Tone	Cause	Solution
01	•	Wheels or side brushes no work	Check wheels or side brushes
02	• •	Cliff sensor or bumper sensor failure	Clean cliff sensor and shake bumper slightly, check whether there is foreign matter
03	• • •	Main body gets stuck	Move main body and start again

Trouble Shooting

Error appearance

Error appearance	Likely cause	Solution
Circle around a small area	Side wheels are jammed	<ul style="list-style-type: none"> - Remove hair and debris from side wheels. - While reinstalling, push the wheels in and out to make sure they can rotate freely. - Restart robot in another spot.
Keep moving backward	Cliff sensor is dirty or broken	Check cliff sensor lens. Clean or replace it if needed.
Bump into obstacles repeatedly	The bumper is stucked	<ul style="list-style-type: none"> - Tap the bumper 10-20 times to remove debris lodged in it. - Loosen the screw of the bumper.
Working time shortened	<ul style="list-style-type: none"> - Battery capacity dropped - Robot is not fully charged 	<ul style="list-style-type: none"> - Replace battery - Recharge robot
CLEAN button light is off while charging	<ul style="list-style-type: none"> - Hair or small debris stuck in charging pins. - Robot is not properly connected to charging pins. 	<ul style="list-style-type: none"> - Clean charging pins - Check if robot is connected to charging pins
Pick up less dirt and debris	Filter is dirty or wet	Clean or replace filter
Spit out litter	Dustbin is full	Empty the dustbin

Trouble Shooting

Error appearance	Likely cause	Solution
Robot doesn't start at scheduled time	<ul style="list-style-type: none"> - Schedule was not saved successfully - Schedule was canceled after you restarted robot - Power Switch is off - Battery is low - Debris jammed in components 	<ul style="list-style-type: none"> - Reset schedule. Wait for a beep to confirm completion of scheduling. - Turn on power switch on robot - Keep the robot's power switch on and put it on charging dock to make sure robot is fully charged for the next job - Turn off the power switch on robot and empty the dustbin - Clean side brushes and main brushes



Note: If all above solutions don't work, please take below actions.

1. Re-set the robot by re-turning on the power switch.
2. If re-set action doesn't work, please contact service_us_ca@iliferobot.com

Product Specifications

Classification	Item	Detail
Mechanical specifications	Diameter	300mm
	Height	81mm
	Weight	2.24kg
Electrical specifications	Power	22W
	Battery type	Li-ion
Cleaning specifications	Dustbin capacity	0.3L
	Charging type	Auto Charging / Manual Charging
	Cleaning mode	Auto, Spot, Edge, Daily schedule
	Charging time	≤ 300 mins
	Cleaning time	≥ 90 mins
Main body button type		Touch button

