

ILIFE-A9

Robotic Vacuum Cleaner

User Manual

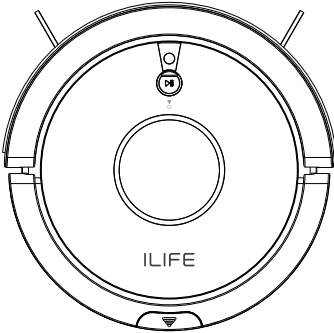

For more information,
visit www.iliferobot.com

ILIFE

Dear Customer,

Thank you for purchasing ILIFE A9 robot vacuum cleaner!
You've joined the millions of people who clean with robots - the smarter way to get it down.

Please take a few moments to read this manual and get acquainted with your robot, to get the best performance from your robot. If you have any problem, please don't worry, you are supposed to contact our customer service first or visit our website at www.iliferobot.com for more information.

Stay connected with us on Facebook and twitter to enjoy these exclusive benefits:

- Get support tailored to your specific robot, including answers to questions, maintenance tips, video demos, live chat and more.
- Get product updates and other valuable information about new robots, exclusive discounts and special promotions.

Connect with us right now at
Facebook: facebook.com/iliferobotics
Twitter: twitter.com/ILIFEROBOTICS

Enjoy a thorough clean every day in your life!
Best regards,
ILIFE Innovation

Table of Contents

Safety Instructions	3
Product Components	5
Main Body	5
Dustbin	5
Charging Dock	6
Remote Control	7
List of Accessories	8
Product Specifications	8
How To Use	9
Charging	9
Start/Pause/Sleep	11
Cleaning Modes	12
Schedule Mode	15
Electrowall	17
APP Download	18
Maintenance	19
Cleaning Side Brushes & Main Brush	19
Cleaning Sensors & Charging Pins	19
Cleaning Dustbin & Filters	20
Troubleshooting	21
Alert Reference	21

Safety Instructions

Safety

1. This robot should not be used by children under aged 8 or mentally challenged people (unless they are under proper supervision). This robot is not a toy. Do not let children sit on the robot.
2. Attend to the robot promptly if error occurs during cleaning. Before using the robot, remove all power cords and small objects on the floor. Roll up carpet tassels and make sure curtains and table cloth are not in contact with the floor.
3. If there is any raised floors such as steps or stairs, test if the robot can detect the height difference. To avoid fall, set up a barrier along the raised floors. Make sure the barrier will not cause people any physical harms such as tripping.
4. Follow the instructions in this user manual. Use factory authorized or recommended accessories only.
5. Make sure the voltage of the charging dock is compatible with the voltage of power supply.
6. Use the robot indoor and in a home environment only. Do not use it outdoor, or in commercial or industrial spaces.
7. Use factory authorized adaptor and charging dock only. Do not use nonrechargeable battery. Refer to “Product Specifications” section for details about battery standards.
8. Do not wash the robot with water.
9. Do not clean the robot with dripping wet cloth.
10. Do not use the robot on floors with accumulated water.
11. Do not use the robot near fire or fragile objects.
12. Do not use the robot under extreme temperatures over 40oC or under -5oC.
13. Do not allow hair, clothes or fingers near openings or mechanical parts of the robot.
14. Do not remove objects such as stones or paper that will be stuck in the robot.
15. Do not remove inflammables such as gasoline, and printer and copier toners with the robot. Do not use the robot in an environment with inflammables.
16. Do not remove cigarette, lighter, matches, ashes or other inflammables that may cause fire.
17. Do not put any objects in the roller brush holder. To ensure smooth rotation of the roller brush, remove dust, batting and hair winding around it.
18. Do not use damaged charging dock.
19. Do not lift the product and charging dock by the power cords. Do not place power cords in gaps around the door, or pull them around sharp edges or corners. Do not allow the robot to run over power cords. Keep power cords from high heat.

Safety Instructions

Product

20. Damaged power cords must be repaired by manufacturer's repair service or certified technicians.
21. Install dustbin and filters properly before using the robot.
22. Do not use the robot in rooms where babies are sleeping.
23. Do not use damaged power cords or charging dock to recharge the robot.
Do not use the robot after a fall, water intrusion or outdoor use, and when it is damaged.
24. Turn off the power switch if the robot will not be used for a long time.

Maintenance

25. Turn off the power switch before cleaning or maintaining the robot.
26. Unplug power cords from the charging dock before cleaning or maintaining the robot.

Disposal

27. Remove battery before discarding the robot.
28. Robot and battery are to be disposed of according to local safety regulations.
29. Do not cremate the robot to avoid explosion.
30. Follow the instructions in this user manual.
Manufacturer is not responsible for any damages caused by improper use.

Product Components

Main Body

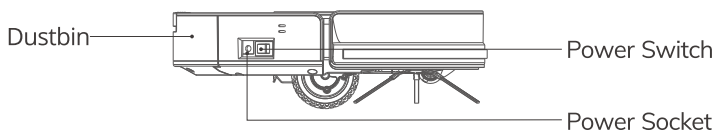
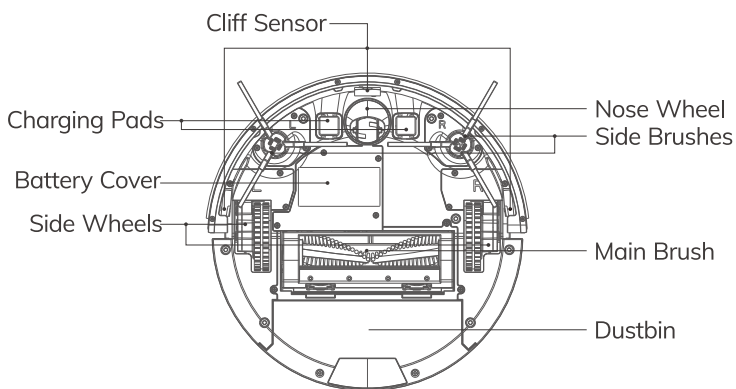
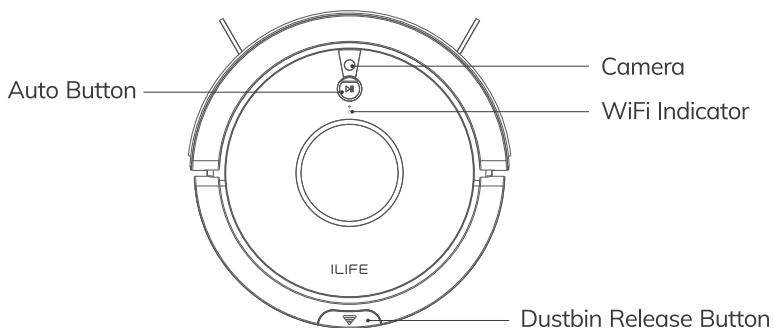

Product Components

Dustbin

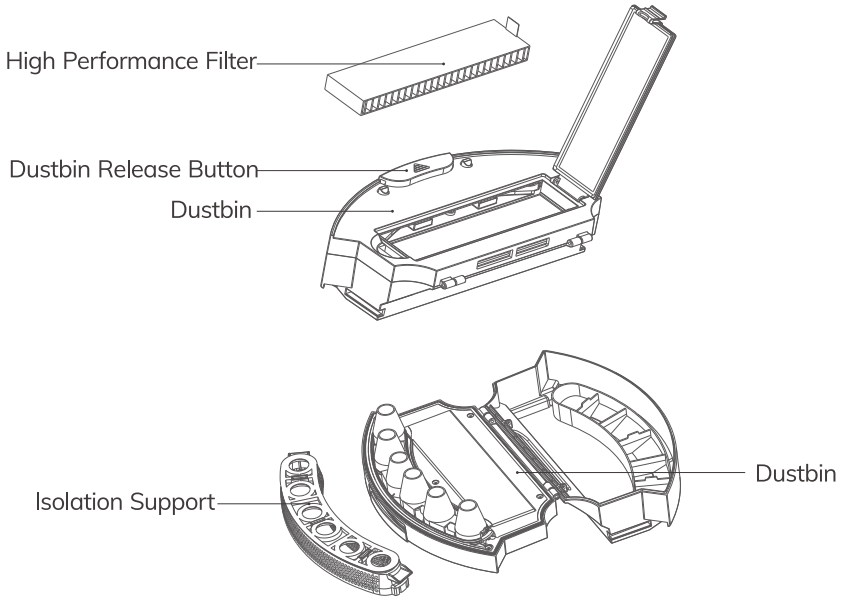

Charging Dock

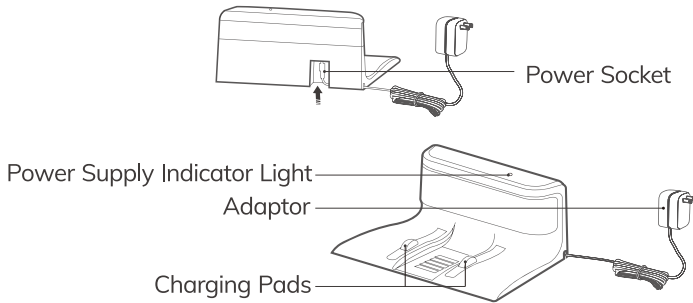

Product Components



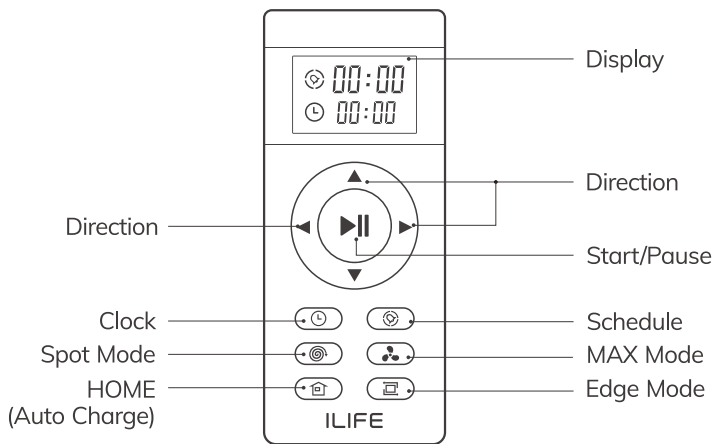





Remote Control

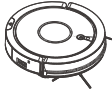

Note: “▲” “▼” “◀” “▶” cannot be used during a cleaning cycle.

Product Components

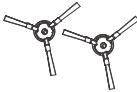
List of Accessories

 Main Body	 Charging Dock	 Remote Control	 Power Adapter	 Rubber Brush
 User Manual	 Electrowall	 (2)Extra Side Brushes	 High Performance Filter	

Product Specifications

Type	Description	Specification
Mechanical	Diameter	330mm
	Height	76mm
	Nett Weight	3.1kg
Electrical	Battery	Li-ion
	Charging Methods	Auto Charging / Manual Charging
Cleaning	Dustbin Capacity	0.45L
	Cleaning Modes	Auto, Spot, Edge, Daily Schedule
	Charging Time	< 300mins
	Cleaning Time	> 110mins
Main Body		Mechanical Button

How To Use

Charging

1. Placing Charging Dock

- Plug the adaptor into the charging dock;
- Put the charging dock against a wall and remove obstacles and reflective objects about 1 meter on both sides and about 2 meters in front;
- Connect to power.

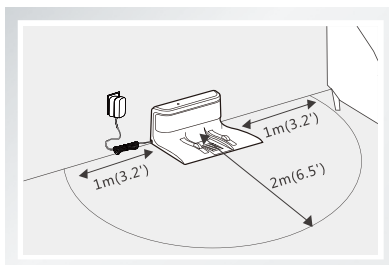
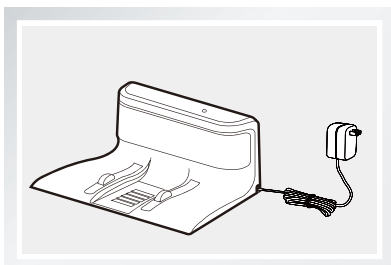

Note:

Once connected to power, indicator light on the charging dock stays on.

2. Turning on Power Switch

Turn on the power switch on the side of the main body.
"—" is ON and "O" is OFF.

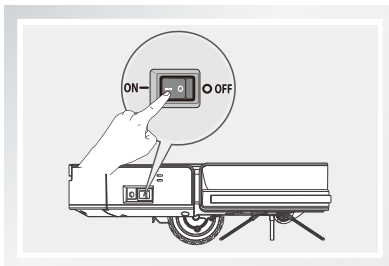

Note:

Do not switch off the robot after use.
Always keep the robot fully charged for the next task.

How To Use

3. Charging the Robot

A. Auto Charge

- When battery runs low in Auto mode, robot will automatically search the charging dock for recharge.
- While on standby, press  button on the remote control. Robot will start searching the charging dock for recharge.

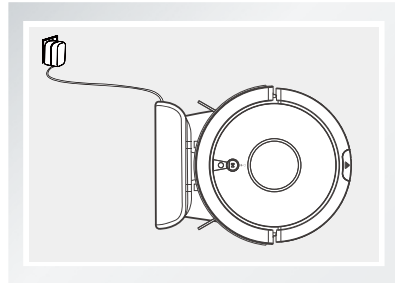
**Reminder:**

To avoid lowered charging performance, make sure the charging pads on the main body and charging dock are clean.

B. Manual Charge

- Turn on the power switch on the side of the main body. Plug in the adaptor and connect to power.

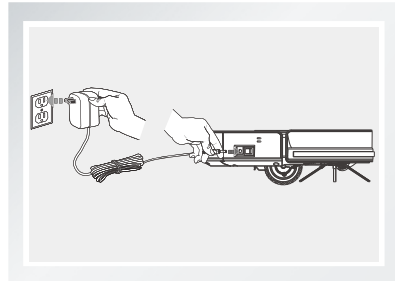
**Reminders:**



1. For regular use, always leave the main body on the charging dock, and make sure its power switch is turned on.
2. If the robot will not be used for a long time, fully charge it before storing in a cool, dry place.
3. Do not charge the robot manually after a cleaning schedule is set. Robot will not execute scheduled cleaning after manual charge.

How To Use

Start/Pause/Sleep

- Sleep: Robot is idle; Power switch is on and indicator light is off.
- Standby: Robot is not working; Power switch is on and light at main button is pulsing.
- Start: Robot is working; Green light at Auto button stays on.

1 Turn on the Robot

- Turn on the power switch on the side of the main body.
- Press  on the main body to start cleaning.
- Press  on the remote control to start cleaning.

Note:

While in Sleep mode, press  to activate standby mode. Press  again to start cleaning.

2 Pause

- Pause means switching from cleaning to standby. To pause a cleaning cycle, press  on the remote control or  on the main body.

Note:

The robot accepts new tasks once it is paused.

3 Sleep

- To enter Sleep Mode:
 - A. Press and hold  for 3 seconds.
 - B. Robot enters Sleep mode automatically after idling for 10 minutes.

Robot

- Auto Mode 
 - A. Press to activate robot from Sleep Mode to standby.
 - B. Press to start cleaning while on standby.
 - C. Press to pause while robot is cleaning



How To Use

Cleaning Modes

Multiple cleaning modes allow robot to perform deep cleaning in different environment and on different floorings. Use the remote control to select a suitable cleaning mode.

- * To activate cleaning modes, make sure robot is on standby: power switch and pulsing green light are on.

1 Auto Mode

The most frequently used cleaning mode. Press  on the main body or  on the remote control. Robot plans a path and cleans along a zigzag pattern. During cleaning, robot detects and cleans areas that have been missed.

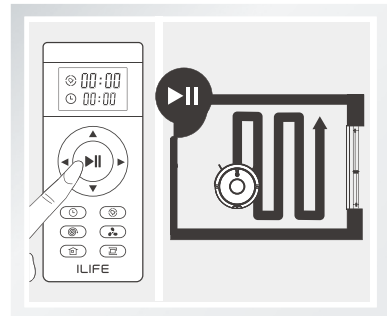

- * Robot plans a cleaning path autonomously during a cleaning cycle. If robot is moved manually or with the remote control, it will plan a new path and may repeat areas that have been cleaned.
- * Robot may stop working briefly during a cleaning cycle. Wait patiently for it to detect areas that have been missed or to revise the cleaning path. The number and duration of these brief stops depend on the complexity of the home environment.

How To Use

2 Spot Mode

Robot takes a spiral path to clean a specific area with concentrated dust and debris.

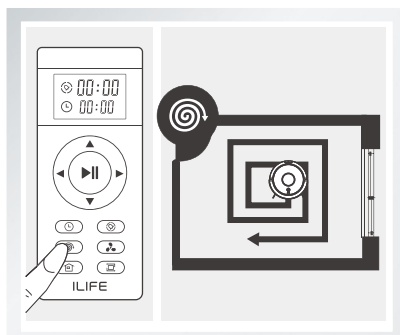

3 Edge Mode

While on standby, robot moves forward until it detects a wall. It cleans around the edges of the walls once.

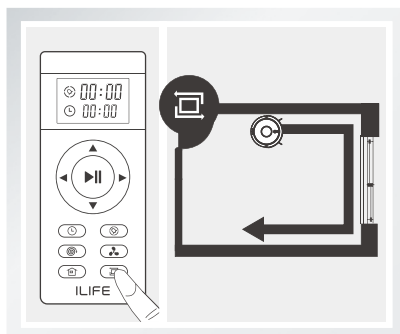

4 MAX Mode

High suction power for areas with concentrated dust. Press MAX button on remote control to increase suction level. Press MAX again to return to normal level.

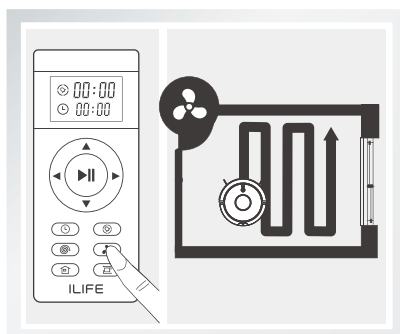

How To Use

5 Auto Charge

When battery runs low during a cleaning cycle, robot will automatically activate "Auto Charge" function -- searching and returning to charging dock for recharge.

* Auto Charge can also be activated by pressing  on the remote control.

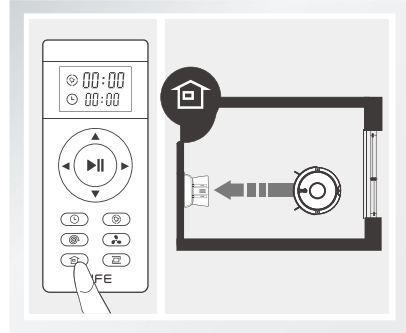

6 Schedule Mode

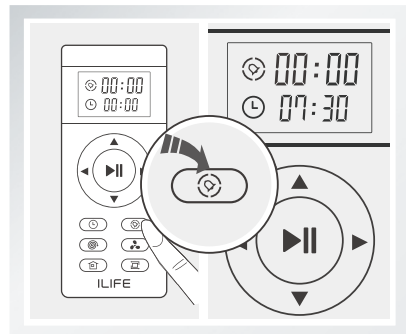

Preset cleaning cycles at any specific time. Tap Schedule button on the remote control. The display will show an icon and flashing 00:00.



How To Use

Schedule Mode

To offer a complete automatic cleaning experience, robot receives preset cleaning schedules. Set local time and schedules with the remote control or mobile APP. Robot will start cleaning automatically at the preset time every day.

* Before setting local time and cleaning schedules, make sure  on the main body is switched on. A green flashing light indicates robot is activated from Sleep mode. To activate robot, tap  on the main body or  on the remote control.

1 Set Local Time with Remote Control

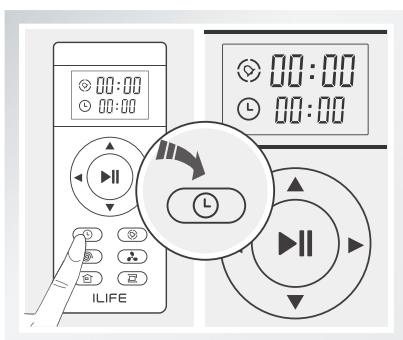

Tap  button. Remote control display will show  and flashing 00:00.

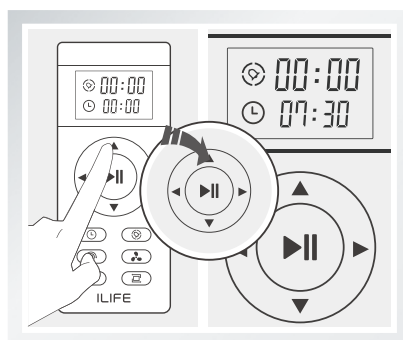

Adjust time with “▲” “▼” button. To set local time, press “◀” “▶” to change from hours to minute.

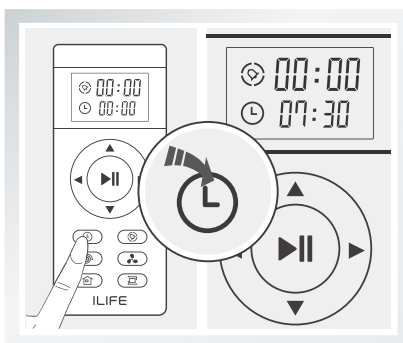

Press  to save local time. Voice announcement will confirm the completion of setting

How To Use

2 Set a schedule

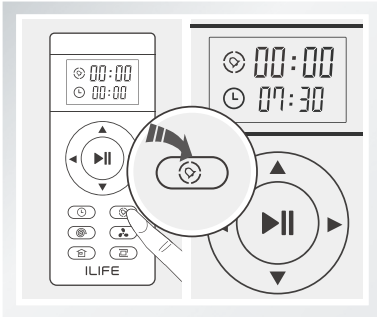

Tap . Remote control display will show  and flashing 00:00.

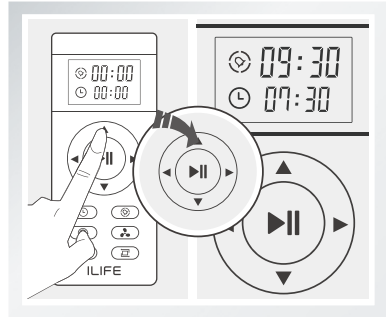

Use direction buttons to adjust schedule time.

Press  to save a schedule. Voice announcement will confirm a successful schedule, and robot will start working at the preset times.

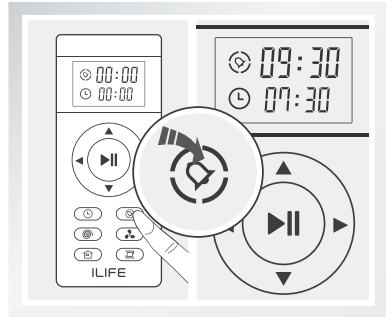

3 Cancel a Schedule

Adjust time to "00:00" and save; or turn off the power switch on the main body.

- * Please pay attention to the voice prompt to see if the robot is successfully scheduled.
- * Rescheduling is required after changing batteries in the remote control.

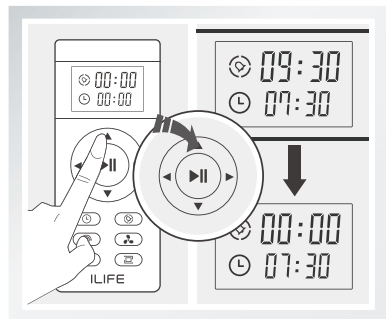

How To Use

Electrowall

Electrowall creates an invisible barrier that A9 will not cross. This invisible barrier can be used to confine A9 to a particular room or area.

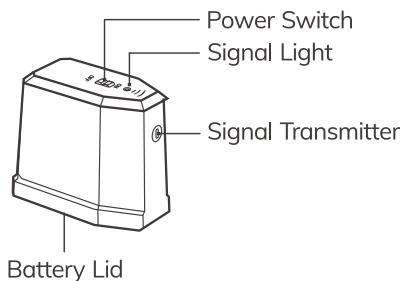

- Install battery first, then turn it on.
- Put the Electrowall on the outside of the doorway you wish to block.
- Ensure the signal logo is facing forward and toward the opening you would like to block.
- Turn off the Electrowall after each use.

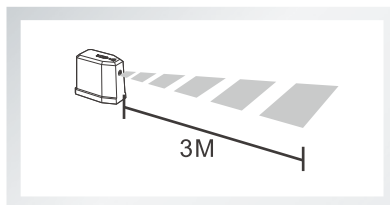
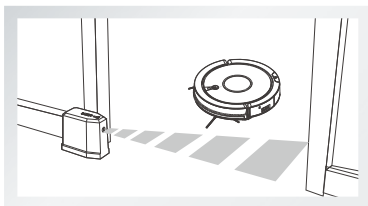

TIPS:

- * Make sure which side is working area according to the stickers on the Electrowall.
- * Place the robot in the "working area" to do cleaning.

APP Download

APP Download

The robot can be controlled by the “ILIFEHOME” app. Scan the QR code to install the app on your iOS or Android device.



 ILIFEHOME



 ILIFEHOME

Maintenance

Make sure the main body is turned off and adaptor is unplugged before accessories maintenance.

Cleaning Side Brushes & Main Brush

Cleaning Side Brushes

Remove side brushes.
Wipe clean with a clean cloth.

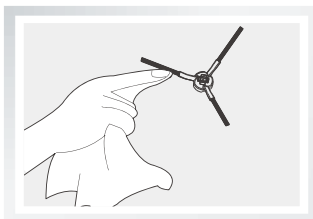

Cleaning Main Brush

Remove main brush cover. Take out main brush. Cut the hair winding around the brush for easy removal.

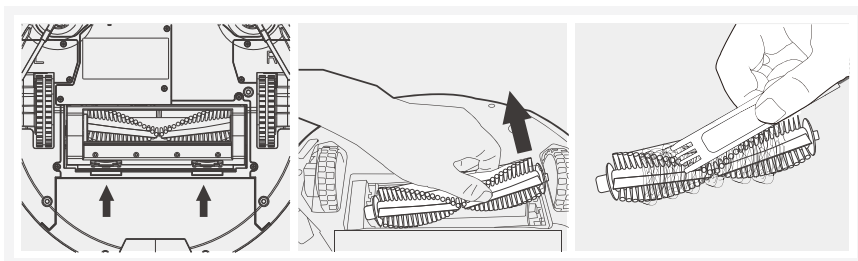

Cleaning Sensors & Charging Pins

Use cleaning tools or a soft cloth to clean the sensors and charging pins:
Note: Remove dust or foreign objects on sensors and charging pins on the charging dock as soon as possible.

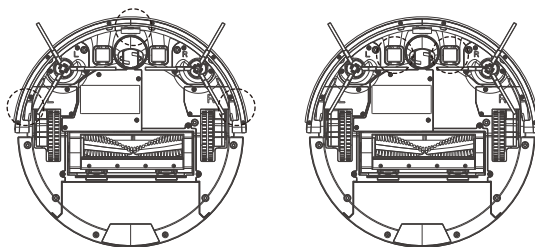

Maintenance

Cleaning Dustbin & Filters

Clean dustbin and filters after each use:

- A. Take out the dustbin. Check the suction port if there is anything stuck in it. Clean suction port if needed.
- B. Wash replaceable primary filter and sponge with water every 15-30 days. Do not squeeze. Air dry after wash.
- C. Tap to remove dust from the high-performance filter. Do not wash with water.

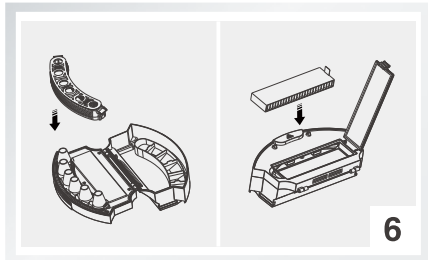
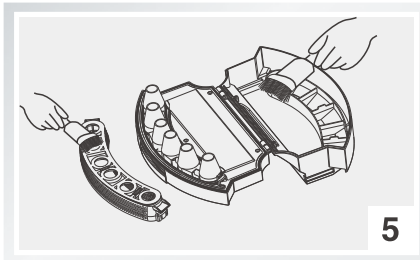
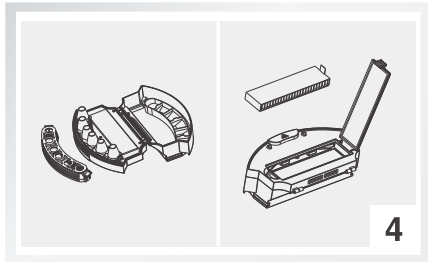
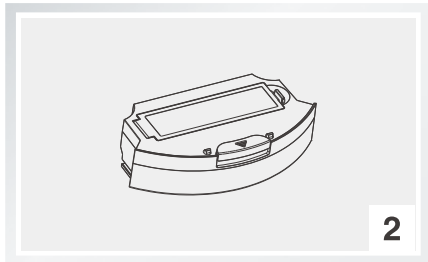
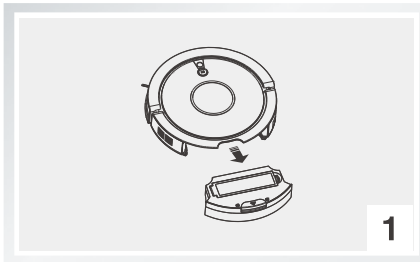

Troubleshooting

Alert Reference

In case of errors, red light stays on with voice announcement.

No.	Voice announcement	Possible causes	What to do
01	Left brush stuck, please remove and clean.	Left side brush error.	Remove and clean left side brush.
02	Right brush stuck, please remove and clean.	Right side brush error.	Remove and clean right side brush.
03	Left wheel stuck, please rotate and clean.	Left side wheel error.	Check and clean left side wheel.
04	Right wheel stuck, please rotate and clean.	Right side wheel error.	Check and clean right side wheel.
05	Main brush stuck, please remove and clean.	Main brush error.	Remove and clean main brush and brush channel.
06	Trapped, please put in an open area.	Robot is stuck.	Restart robot at an unblocked spot.
07	Please inspect and tap bumper to confirm movement is normal.	Bumper error.	Tap bumper to confirm it moves normally and is on track.
08	Cliff sensors blocked, please wipe them.	Cliff sensors error.	Check cliff sensors.
09	Nose wheel issue, please remove and clean.	Nose wheel error.	Pull nose wheel and holder out to clean.
10	Suspended, please put back on ground.	Robot is lifted up.	Relocate robot to a flat surface.

Reminders:

If the solutions above don't help:

1. Restart the main body by turning on the power switch on the side.
2. If problems persist, send robot to the nearest repair service center.