

G50

Cordless Stick Vacuum Cleaner

User Manual



EASINE
by ILIFE

For more details, please visit www.iliferobot.com

Thank you for choosing EASINE G50 Cordless stick vacuum cleaner !
You've joined millions of people to get the cleaning done in high efficiency.

This manual helps you to keep your vacuum cleaner performing at its best. Please take a few moments to read through it.

You may also connect with us on Facebook and Instagram to enjoy exclusive benefits:

- Get model-specific customer support, including Q&A, maintenance tips, demo videos, live chat and more;
- Get the most recent product updates including new product launches, exclusive discounts and special promotions.

You may find us on:

Facebook: facebook.com/iliferobotics

Twitter: twitter.com/ILIFEROBOTUS

If you have any questions, please contact our customer service for assistance or visit www.iliferobot.com for more information.

Enjoy the high-performance cleaning of EASINE G50.

ILIFE Innovation

ILIFE Customer Service



1-800-631-9676 (Toll free for USA & Canada)

Mon-Fri: 9:00 am - 5:00 pm CST



support@iliferobot.com

Contents

1. Important Safety Instructions	1
2. Product Introduction	5
2.1 List of Accessories	5
2.2 Product Layouts	6
3. Product Operation	7
3.1 Assemble and Detach the Device	7
3.2 How to Install and Use Wall Mount	8
3.3 Indicator Light Introduction	9
3.4 Charging	9
3.5 How to Use the Device	10
4. Maintenance	11
4.1 Clean the Dustcup and Filters	11
4.2 Clean the Floor Head and Roller Brush	12
4.3 Clean the Side Brush	13
5. Common Failure Analysis and Treatment	14
6. Product Technical Parameters	15
7. Disposal Information	16

Important Safety Instructions



SAFETY INSTRUCTIONS

- When using electrical appliances, basic safety precautions should always be followed.
- This appliance can be used by children aged from 8 year and above and persons with reduced physical, sensory or mental capabilities or lack of experience and knowledge if they have been given supervision or instruction concerning use of the appliance in a safe way and understand the hazards involved.
- Children shall not play with the appliance, cleaning and user maintenance shall not be made by children without supervision.
- This appliance is not a toy.
- Unless they are older than 8 and under supervision, children should not use or maintain the appliance.
- Keep the appliance out of the reach of children when it is switched on or cooling down.
- Make sure that the input voltage of the vacuum cleaner's adapter fits your local voltage before connecting the appliance to the power for charging.
- Dry your hands before operating the appliance.
- Do not pull the cord to remove the adapter from the mains power supply, unplug the appliance by hand.
- Do not use the adapter to recharge non-rechargeable batteries.
- Do not use any damaged accessories or adapters.
- Do not use the appliance if it has been dropped or if there are visible signs of damage.
- Do not use the appliance for anything other than its intended use.
- Do not use any parts/accessories or adapters other than those supplied with this appliance, as this may cause damage.
- Do not use this appliance outdoors.
- Do not use this appliance if any of the openings are blocked.

Important Safety Instructions

- Do not use the appliance to pick up flammable liquid, matches, cigarette ends, hot ashes or any hot, burning or smoking objects.
- The hose should be checked regularly and must not be used if damaged.
- Take care when equipping accessories with rotating parts as this could cause entrapment.
- Switch off the appliance and disconnect it from the mains power supply before changing or fitting accessories.
- Always ensure that the appliance has fully cooled before maintaining the appliance or cleaning.
- The use of an extension cord with the appliance is not recommended.
- Only use the appliance with the power supply unit provided.
- Do not operate this appliance by an external timer or separate remote control system.
- This appliance is intended for domestic use only. It should not be used for commercial purposes.
- Improper repairs may place the user at risk of harm.
- This appliance contains no user-serviceable parts. If the power supply cord, plug or any part of the appliance is malfunctioning or if it has been dropped or damaged, only a qualified electrician should carry out repairs.
- Keep the appliance away from heat or sharp edges that could cause damage.
- Keep the appliance away from other heat-emitting appliances.
- Keep the appliance free from dust, lint, hair or anything that may reduce the airflow of the appliance.
- Do not immerse the appliance in water or any other liquid.
- Do not expose the appliance to rain.
- Do not store the appliance in direct sunlight or in high humidity conditions.

- **Caution:** The extension tube contains electrical connections. Do not use to suck up water. Do not immerse in water for cleaning. The extension tube should be checked regularly and must not be used if damaged.

Important Safety Instructions



BATTERY SAFETY

- If the battery pack becomes exhausted quickly after fully charged, it should be removed from the product to avoid leakage.
- In the event of the battery pack leaking, do not allow any liquid to come into contact with the skin or eyes.
- If the contact has been made, wash the affected area with copious amounts of water and seek medical advice.
- Keep the battery pack out of the reach of children.
- Do not leave battery packs on charge for prolonged periods of time.
- Do not use any charger other than that specifically provided for use with the product.
- The supply terminals are not to be short-circuited.
- Do not store above 60°C, avoid storing in direct sunlight.
- Do not use any battery packs that are not designed for this product.
- Do not dispose of the battery pack in a fire.
- Do not crush, puncture, dismantle or otherwise damage the battery pack.
- Do not dismantle, open or shred battery packs.
- Do not expose the battery pack to heat or fire as it may explode.
- Do not subject the battery pack to mechanical shock.
- Do not dispose of the exhausted battery pack in household waste.
- The plug must be removed from the socket-outlet before cleaning or maintaining the appliance.
 - the battery must be removed from the appliance before it is scrapped.
 - the appliance must be disconnected from the supply mains when removing the battery.
 - the battery is no be disposed of safely.
- To dispose of the exhausted battery pack, take it to a local recycling station, contact the local government offices for further details, this appliance is fitted with a 21.6V 2000mAh Li-ion rechargeable battery.



WARNING

Read all safety warnings and instructions. Failure to follow the warnings and instructions may result in electric shock, fire and/or serious injury.

1. Prevent unintentional starting. Ensure the switch is in the off position before connecting to the battery pack, picking up or carrying the appliance. Carrying the appliance with your finger on the switch or energizing appliance that have the switch on invites accidents.
2. Disconnect the battery pack from the appliance before making any adjustments, changing accessories or storing the appliance. Such preventive safety measures reduce the risk of starting the appliance accidentally.
3. Recharge only with the charger specified by the manufacturer. Chargers that are suitable for other battery packs may cause risk when charging this appliance.
4. Use the appliances only with specifically designated battery packs. The use of any other battery packs may create a risk of injury and fire.
5. When the battery pack is not in use, keep it away from other metal objects, like paper clips, coins, keys, nails, screws or other small metal objects, that can make a connection from one terminal to another. Shorting the battery terminals together may cause burns or a fire.
6. Under abusive conditions liquid may be ejected from the battery, avoid contact. If contact accidentally occurs, flush with water. If liquid contacts eyes, additionally seek medical help. Liquid ejected from the battery may cause irritation or burns.
7. Do not use a battery pack or appliance that is damaged or modified. Damaged or modified batteries may exhibit unpredictable behavior resulting in fire, explosion or risk of injury.
8. Do not expose a battery pack or appliance to fire or excessive temperature. Exposure to fire or temperature above 130°C (265°F) may cause an explosion.
9. Follow all charging instructions and do not charge the battery pack or appliance outside of the temperature range specified in the instructions. Charging improperly or at temperatures outside of the specified range may damage the battery and increase the risk of fire.
10. Have servicing performed by a qualified repair person using only identical replacement parts. This will ensure that the safety of the product is maintained.
11. Do not modify or attempt to repair the appliance or the battery pack (as applicable) except as indicated in the instructions for use and care.

Product Introduction

List of accessories

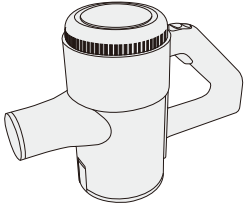

Main Body

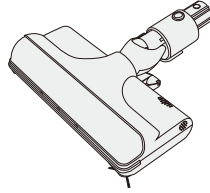

Motorized Floor Head

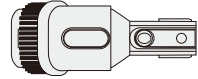

2 in 1 Suction Nozzle



Crevice Tool



Wall Mount

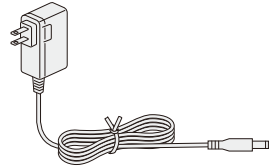

Power Adapter

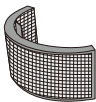

High-Efficiency Filter



Side Brush



User Manual



Extended Wand

Product layouts

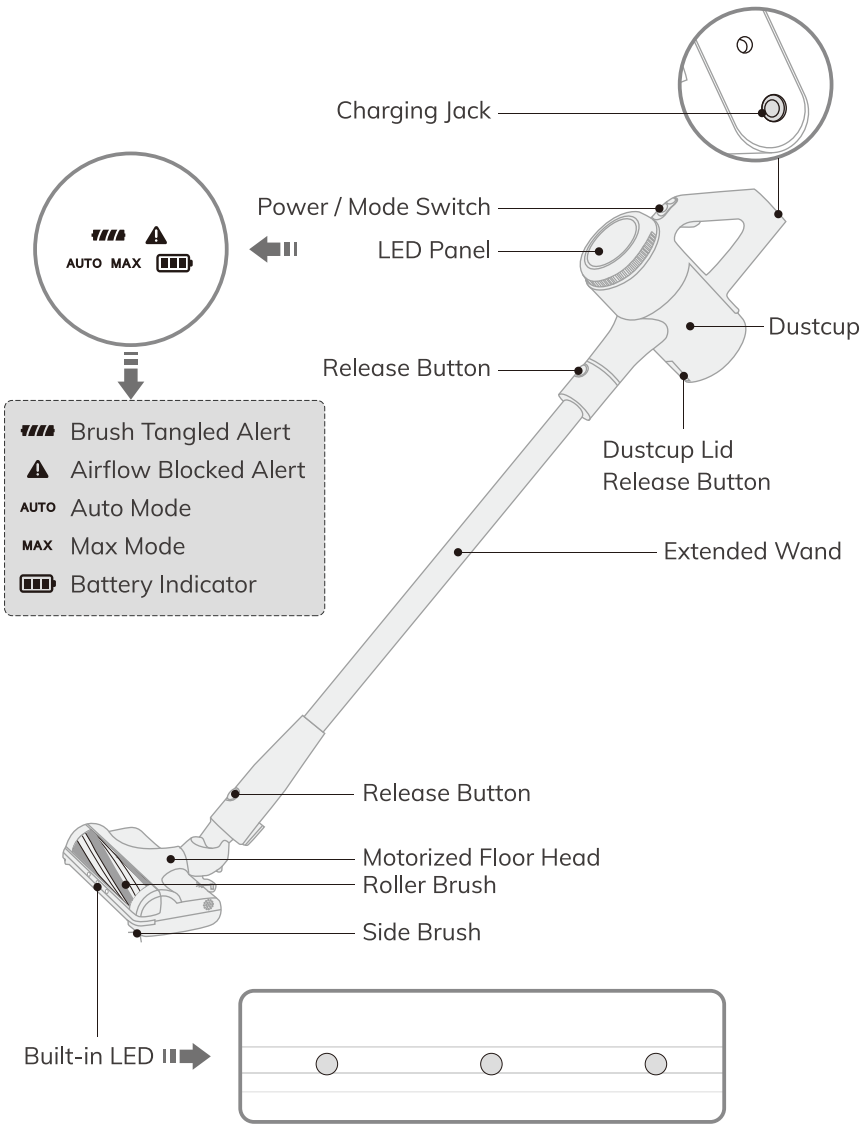

Product Operation

Assemble and Detach the Device

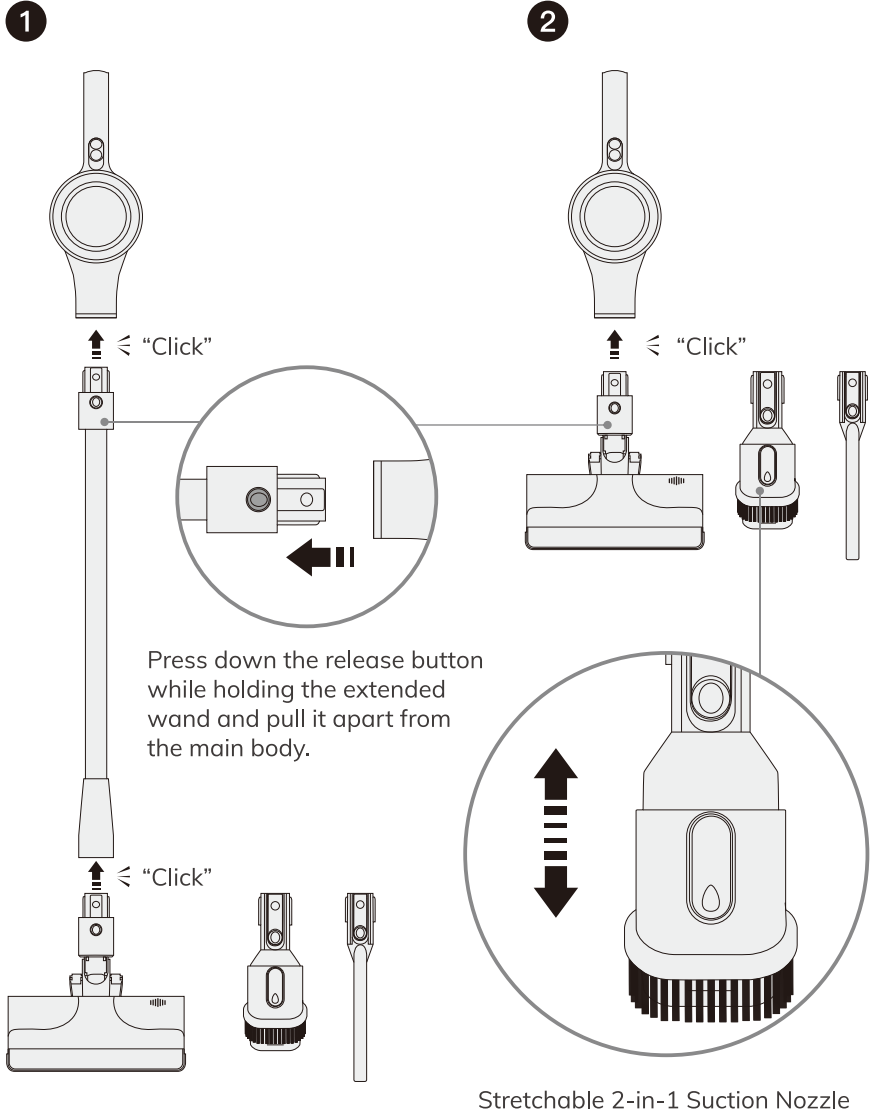

How to Install and Use Wall Mount

- Install the wall mount next to the outlet. Store the stick vacuum in a cool and dry place, avoid direct sunlight.
- Choose the appropriate wall type and make sure that the mount is firmly installed. Make sure that there are no pipes (gas pipes, water pipes) or cables, wires or sewers directly behind the installation area.
- Use a 6mm drill bit to make holes for fastening the wall mount. After drilling the holes, insert the expansion tube, then install the wall mount, and finally fasten the screws.

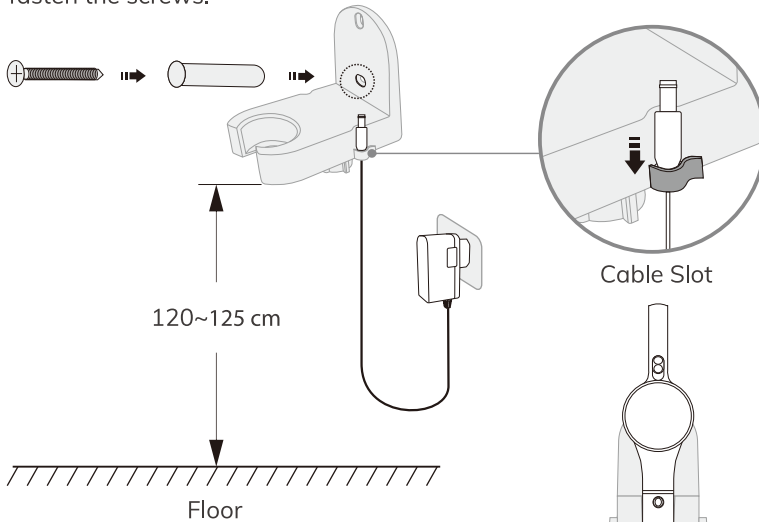



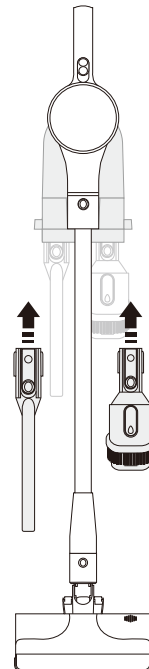



- Please place the device on the wall mount or storage dock when not in use.



Product Operation

Indicator Light Introduction

Main Body Status	Indicator Light on LED Screen
Low Battery Power	 The first column flashing
Fully charged	 White static lights on
Battery Temperature too High	 The first and third columns flash for 30 seconds
Abnormal Charging	 All columns flash for 30 seconds
Shortcut Circuit Protection	 The First and third columns flash for 5 seconds MAX White light flashes for 5 seconds
Brush Tangled Alert	 Red light flashes for 30 seconds
Airflow Blocked Alert	 Red light flashes for 30 seconds
Auto Mode	AUTO White static lights on
Max Mode	MAX White static lights on

Charging

! Attention!

1. The battery is not fully charged at the factory, please kindly charge it fully before the first use.
2. The device will automatically stop working and start to charge when connecting to the outlet for charging.
3. The battery temperature becomes high after continuous working, which will increase the charging time. It is recommend to cool down the main body for 30 minutes before recharging the battery.

Please Kindly read the “Important Safety Instructions” on Page2-4 of this manual before the first use.

Battery Indicator

The first column light flashing: battery power<6%

The first column light on: 6%<battery power<33%

The second column light on: 33%<battery power<66%

The third column light on: battery power>66%

LED Display

The battery indicator flashes in breath rhythm with the matched power volume it has been charging. The light is off in 5 minutes after the battery fully charged.

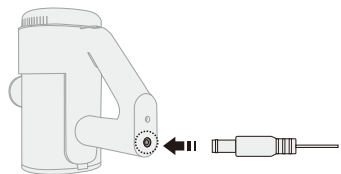

How to Use the Device

- Make sure the high-performance filter, top lid, and cyclone cavity are installed well before vacuuming.
- Do not block the vent while vacuuming.
- When cleaning up fine particles (like flours), use the vacuum only for small quantities of dust and trash.
- Do not vacuum sharp and hard objects, such as small toys, pins, and paperclips, to avoid damaging the device and floor.
- Mind your safety when cleaning dangerous areas (like stairs, windows) with the device.
- Do not leave the floor head in one place on the fragile floor while cleaning.
- The roller brush in the floor head might cause uneven gloss on the waxed floor during cleaning. Wipe the corresponding floor with a wet cloth, wax it, and air-dry it if it occurs.
- Do not place the device on the chairs or countertops.
- Pay attention to the brushes, which might cause slight irritation on your skins. Please wash hands after touching the brushes.

Turn on/off the device

Push the switch forwards to start cleaning, with the built-in LED lights on.
Push the switch backwards to stop working.

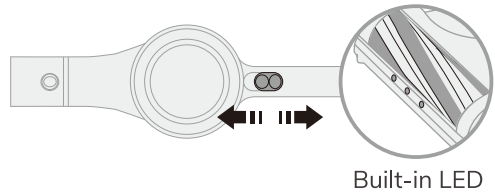

Auto mode

Push the switch forward in one level to react auto mode, the static light of the "AUTO" icon on the LED panel will be on.

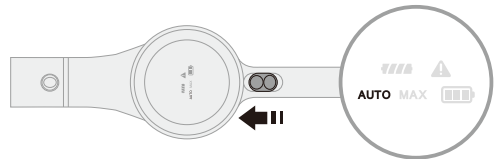

Max mode

Push the switch forward in two levels to react max mode, the static light of the "MAX" icon on the LED panel will be on.

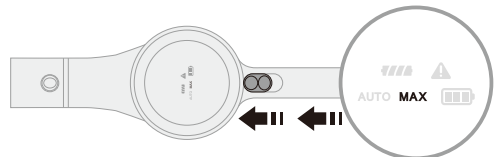

Maintenance

! Attention!

1. Be sure to use the original accessories, otherwise the warranty service is unavailable.
2. Store the device in the cool and dry places when not using it for a long time. Do not place the machine in direct sunlight or humid environment.
3. If the device will not be used for a long time, please fully charge the battery and plug out the power adapter, and make sure the device is powered off before placing it in the cool and dry place. Charge the battery at least once every 3 months to avoid the failure to charge caused by over self-discharging.

Clean the Dustcup and Filters

To keep the suction of the device, please clean up the dust in dustcup and filters regularly. (Tips: Please kindly install all the accessories by step after they are totally air-dried.)

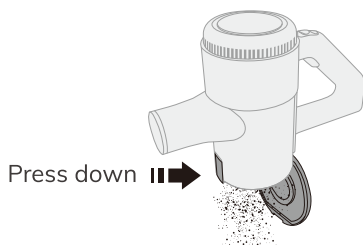

Press down the release button to empty the trash.

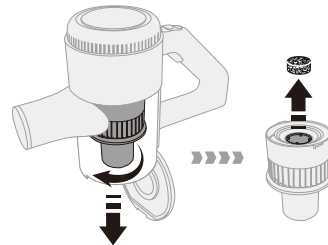

Rotate clockwise to detach the filter kits and take out the filter.

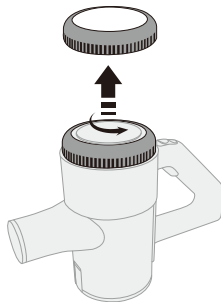

Rotate anti-clockwise to detach the top lid.

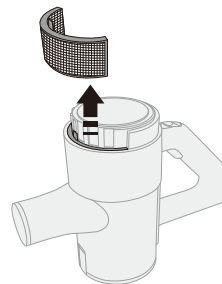

Take out the high-efficiency filter upwards.

Rinse the components below at least once a month (DO NOT wash the unmentioned components). Make sure the filters are totally air-dried before installing them into the dustcup.

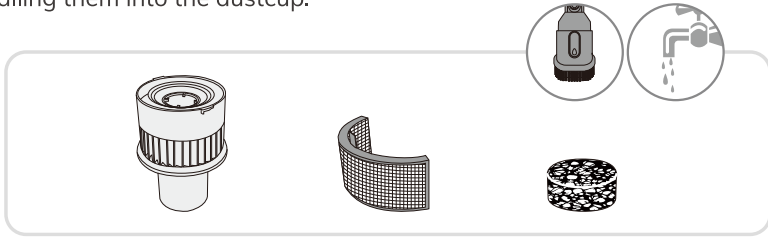

Clean the Floor Head and Roller Brush

! Attention!
To keep the motorized floor head rotates and works smoothly, please clean the wheels and roller brush once they are tangled or dirty.

1. Press down the release button to detach the floor head.

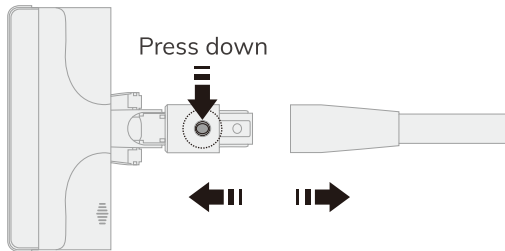

2. Lift up the buckle of the roller brush cover and take out the roller brush for cleaning. Re-install the roller brush in reverse order after cleaning.

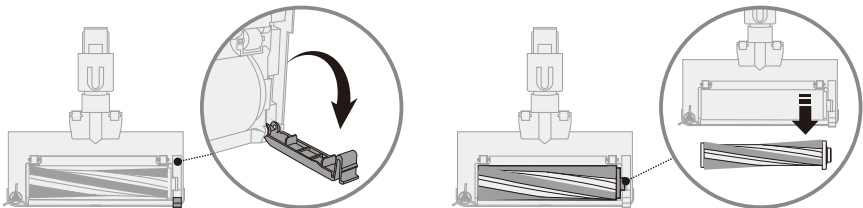

Maintenance

Clean the Side Brush

Lift up the side brush to detach it.

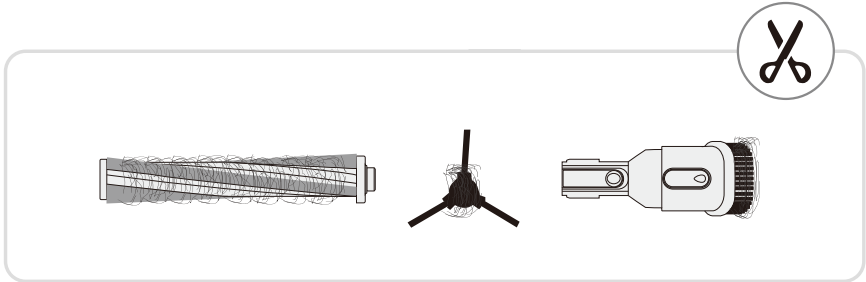
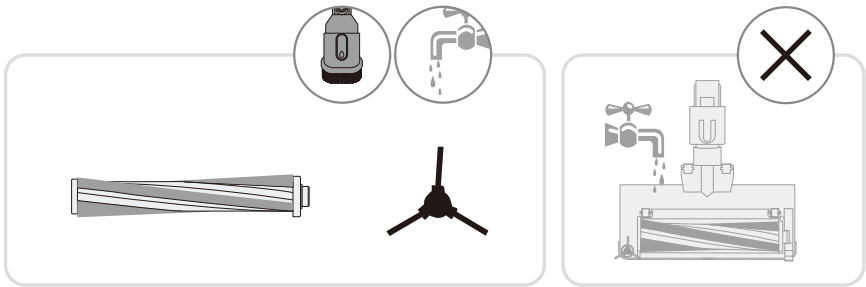
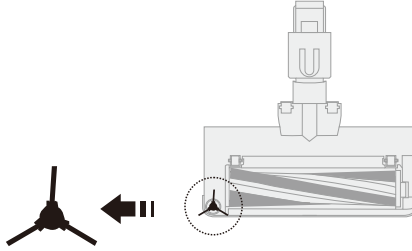

Tips:

The floor head is forbidden to wash, because there are electronic parts inside. Please clean up the wrapped hair with scissors, and clean up the dust clinging to the brush with cloth or brush.

Common Failure Analysis and Treatment

Check out the contents below to deal with the abnormal problem when the device doesn't work normally.

The Device doesn't work.	<ol style="list-style-type: none">1. The battery is in low power. Please fully charge it before using it.2. High temperature protection is on because of the long-time use. Restart the device after it is cooling down.3. The airflow is blocked, or the roller brush is stuck. Please kindly clear the foreign objects and restart the device.
The suction reduces.	<ol style="list-style-type: none">1. The dustcup is full. Please dispose of the trash.2. The roller brush is tangled. Please remove the foreign objects from it. The airflow is blocked. Please remove the blockages in the extended wand, filter, or vent.3. Too much dust stuck on the high-efficiency filter. Please clean it up.4. The battery power is too low. Please charge it immediately.
The  icon doesn't light up while charging	<ol style="list-style-type: none">1. Check out if the power adapter plugs in well.2. The battery is fully charged and becomes dormant.
The battery is charged slowly.	The battery temperature is too high or low to be charged. Wait for the battery temperature becomes normal before charging.

Product Technical Parameters

Item	Cordless Stick Vacuum Cleaner
Model	G50
Net weight	2.0kg
Dustcup capacity	0.65L
Dimension	1150 X 265X258 mm
Rated voltage	21.6V
Rated power	150W
Item	Adapter
Input	AC 100-240V~50/60HZ 0.5A max
Output	DC 28V  600mA

Disposal

The battery used with this device must not be disposed of in household waste.

The device and the battery must be disposed of properly.

The housing of the battery must never be opened, and must be disposed of as a whole.



This product is subject to the provisions of European Directive 2019/19/EC.

The symbol showing a wheelie bin crossed through indicates that the product requires separate refuse collection in the European Union,

This applies to the product and all accessories marked with this symbol.

Products identified with this symbol may not be discarded with normal household waste, but must be taken to a collection point for recycling electric and electronic appliances.



This recycling symbol marks e.g. an object or parts of the material as valuable for recycling. Recycling helps to reduce the consumption of raw materials and protect the environment.



Packaging

When disposing of the packaging, make sure you comply with the environmental regulations applicable in your country.

Distributor: Shen Zhen ZhiYi Technology Co., Ltd

3rd Floor, Bld B, Hytera Technology Park, No.3, 4th of Baolong Road, Longgang, Shenzhen, China

