

# ILIFE-V20

Robotic vacuum cleaner

# User Manual

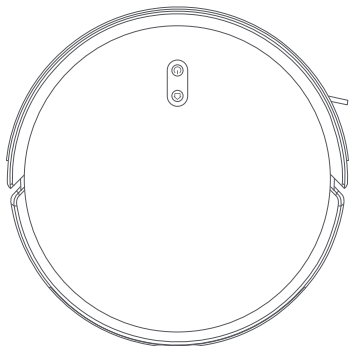

For more details, please  
visit [www.iliferobot.com](http://www.iliferobot.com)

**ILIFE**



Dear Customer,

Thank you for purchasing ILIFE V20 robotic vacuum cleaner!  
You've joined the millions of people who clean with robots - the smarter way to get it done.

Please take a few moments to read this manual and get acquainted with your robot, to get the best performance from your robot. If you have any problems with your robot please do not hesitate to contact our customer service or visit our website at [www.iliferobot.com](http://www.iliferobot.com) for more information.

Stay connected with us on Facebook and Twitter to enjoy these exclusive benefits:

- Get support tailored to your specific robot, including answers to questions, maintenance tips, video demos, live chat and more.
- Get product updates and other valuable information among the first to find out about new robots, exclusive discounts and special promotions.

Connect with us right now at  
Facebook: <https://www.facebook.com/ilifeglobal>  
Twitter: [https://twitter.com/ilife\\_global](https://twitter.com/ilife_global)

Enjoy a thorough cleaning every day!  
Best regards,  
ILIFE Innovation

## ILIFE Customer Service



[support@iliferobot.com](mailto:support@iliferobot.com)

## Table of Contents

<b>Safety Instruction</b> .....	3
<b>Product Composition</b> .....	5
List of accessories .....	5
Host introduction .....	6
Sensor and structure .....	6
Charging dock .....	7
Remote control .....	7
<b>Product Operation</b> .....	9
Precautions .....	9
Charging .....	10
Power on/off .....	11
Sweep/Pause .....	11
Charge .....	11
Automatic sweeping .....	12
<b>App Download</b> .....	13
<b>Routine Maintenance</b> .....	17
Main brush .....	17
Edge brush .....	17
Dustbin and filters .....	18
Clean the dustbin .....	18
Water tank use .....	19
Other spare parts .....	20
Maintenance of the battery .....	21
<b>Normal questions</b> .....	22
<b>Product Specification</b> .....	23

## Safety Instruction

---

### Warnings

1. This robot should not be used by children under 8 years old or people with mentally challenged, unless they are under supervision. Do not let children sit on the robot or use it as a toy.
2. Attend to the robot promptly if an error occurs during cleaning. Before using the robot, remove all power cords and small objects on the floor. Roll up carpet tassels and make sure curtains and table cloth are not in contact with the floor.
3. If there are hanging steps or stairs, please test if the robot can detect them before use. If not, please set up barriers to avoid falling down, and make sure that the barriers cause no harm to people.
4. Follow the instructions in this user manual. Use factory authorized or recommended accessories only.
5. Make sure the voltage of the charging dock is compatible with the voltage of power supply.
6. Use the robot indoor and in a home environment only. Do not use it outdoor, or in commercial or industrial spaces.
7. Use factory authorized adapter and charging dock only. Do not use non-rechargeable battery. Refer to "Product Specifications" section for details about battery standards.
8. Do not soak the robot in water and do not rinse the robot under the faucet.
9. Do not clean the robot with dripping wet cloth.
10. Do not use the robot on floors with ponding water.
11. Do not use the robot near fire or fragile objects.
12. Do not make the cloth, humans hair, finger, or other parts of the body close to the open or the running mechanism of the robot.
13. Do not use the robot on floors with stones or paper to avoid being stuck.
14. Do not use the robot in areas with any flammables, such as gasoline, toner and so on. Or use the robot to clean any burning objects, like cigarettes, ashes or matches, or anything that may cause a fire.
15. Do not use damaged charging dock.

## Safety Instruction

---

16. Do not lift up the robot or the charging dock by the power cord, and keep the power cords away from heat and avoid it being trapped around doors, sharp edges or corners.
17. Damaged power cords must be repaired by manufacturer's repair service or certified technicians.
18. Install dustbin and filters properly before using the robot.
19. Do not use the robot in rooms where babies are sleeping.
20. Do not use damaged power cords or charging dock to recharge the robot. Do not use the robot if it's damaged by falling down, or soaking in water.
21. Turn off the power switch if the robot will not be used for a long time.
22. Turn off the power switch before cleaning or maintaining the robot.
23. Unplug power cords from the charging dock before cleaning or maintaining the robot.
24. Remove battery before discarding the robot.
25. Robot and battery are to be disposed of according to local safety regulations.
26. Do not cremate the robot to avoid the explosion.
27. Follow the instructions in this user manual. Manufacturer is not responsible for any damages caused by improper use.

**Note:**

This product could not be used by children, mentally challenged people or people lack of related experience and knowledge (Unless there people instruct or supervise them).

## Product Composition

---

### List of accessories

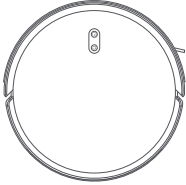

Main Body

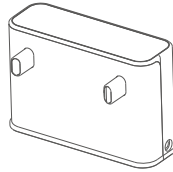

Charging Dock

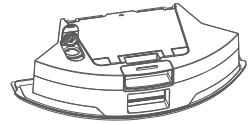

2-in-1 Dustbin and Water Tank

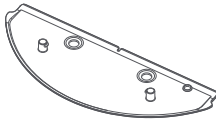

Duster Component

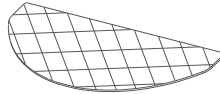

Mop Cloth



Remote Control



Cleaning Tool

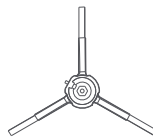

Extra Side Brush



User Manual

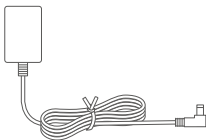

Power Adapter

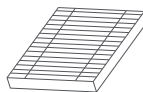

Filter

## Product Composition

### Host introduction

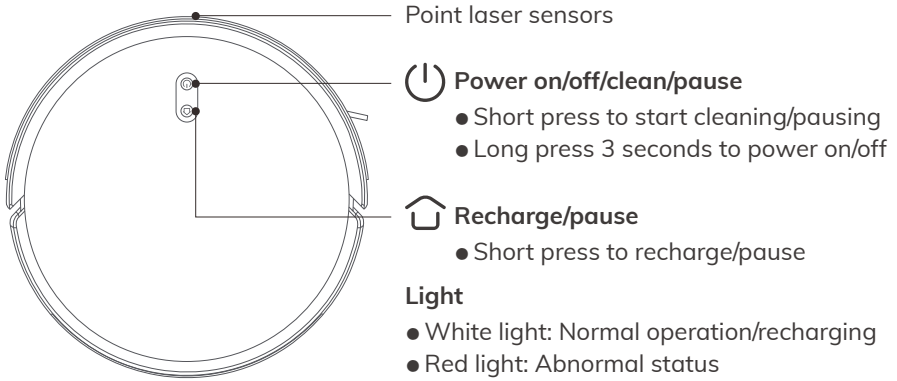

### Sensor and structure

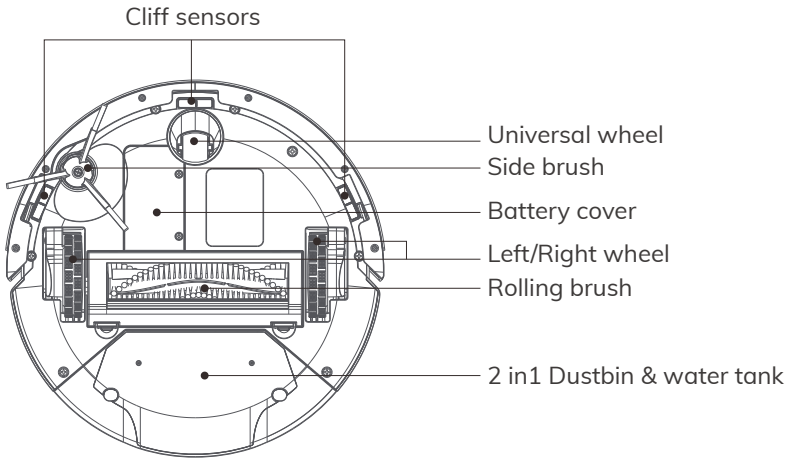



## Product Composition

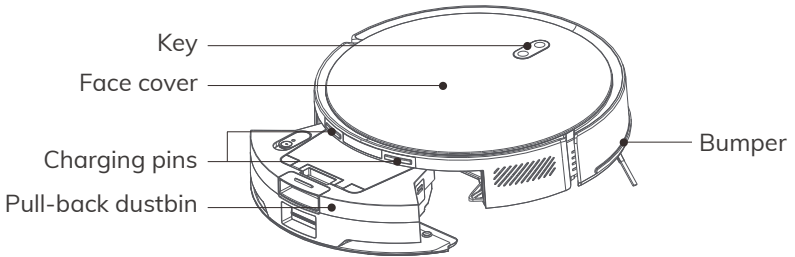

## Charging dock

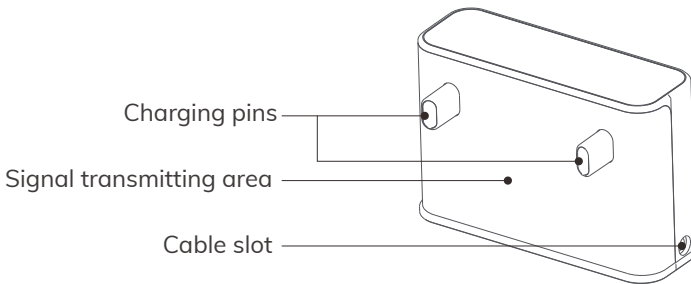

## Remote Control

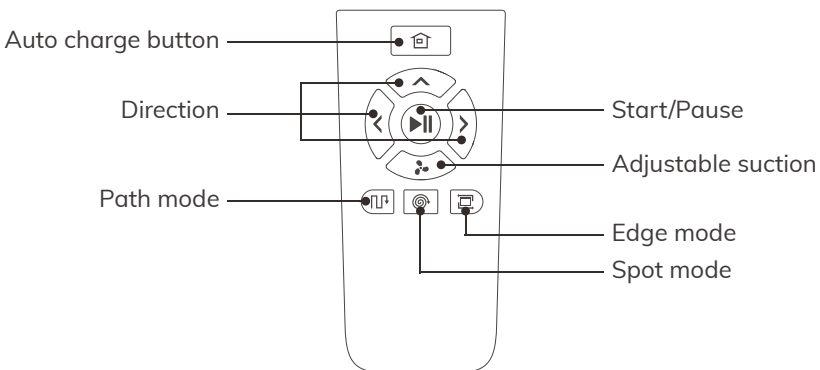

## Product Composition

---

### 1 Clean/Pause button

- Press the button to switch the robot from sleep mode to idle mode.
- Press the button when in idle mode to start cleaning.
- Press the button to Pause the robot during its operation.

### 2 Direction buttons

#### A. “^” Forward

Press the button to move the robot forward.

#### B. “⚙️” Adjustable suction

Press the button to switch suction in working mode.

#### C. “<” Left

Press the button and the robot will turn left.

#### D. “>” Right

Press the button and the robot will turn right.



Note: “^” cannot be used during a cleaning cycle.

### 3 Auto charge button

Press the button and the robot will return to the charging dock for recharging.

### 4 Edge cleaning button

Press the button to start border cleaning.

### 5 Spot mode button

Press the button to start the spot cleaning.

### 6 Path mode

Press the button to start cleaning under path mode.

### 7 MAX mode

During the cleaning process, if there is a lot of dust, press this button to increase the suction power of the robot. Press it again to switch to the max suction power, press it again to switch to the mute mode suction, and press it again to switch back to auto mode suction.



#### Note:

Please install two AAA/R03 batteries before using the remote control.  
Please take out the batteries if the remote control won't be used for a long time.

## Product Operation

### Precautions

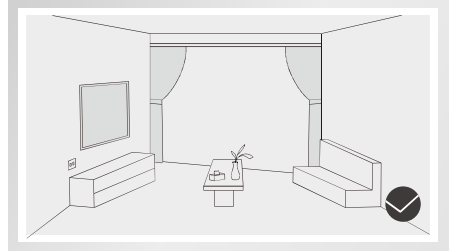
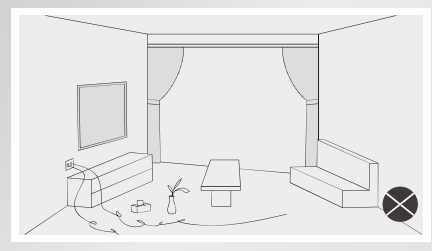

Before starting the vacuum cleaner, clean up wires and sundries scattered on the ground, and remove easy-to-fall, fragile, valuable and potentially dangerous items. Avoid being entangled, stuck, dragged or knocked down by the main unit; otherwise, personal injury or property damage may be caused.

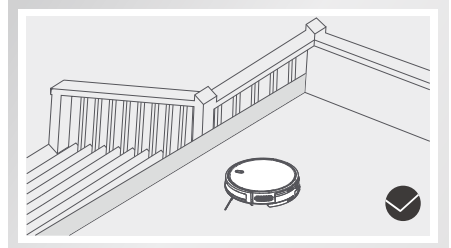
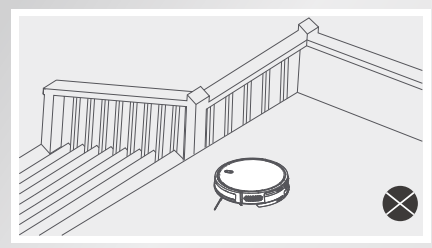

When used in a suspended circumstance, it shall be protected by rails to avoid accidental falling or pushing other articles from falling; otherwise, personal or property damage may be caused.



#### Tips:

1. During the first cleaning process, it is recommended to follow the host throughout the process to assist in dealing with some possible small problems, and the host can be cleaned smoothly in the future cleaning.
2. If some areas do not need to be cleaned or may be stuck, you can set a forbidden area in the mobile App to block the host from entering the above areas.
3. Do not let the robot suck up hard or sharp objects (such as decoration waste, glass, iron nails, etc, otherwise it may scratch the robot and the ground.

## Product Operation

### Charging

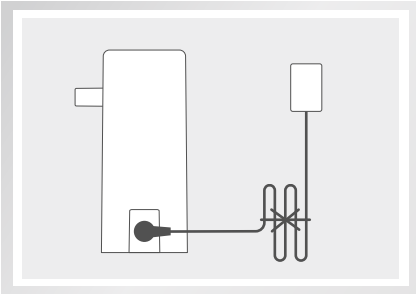

**1** Connect the power cord, and collect the redundant cable.

- Wrap the excess wire around the spool and plug it in.

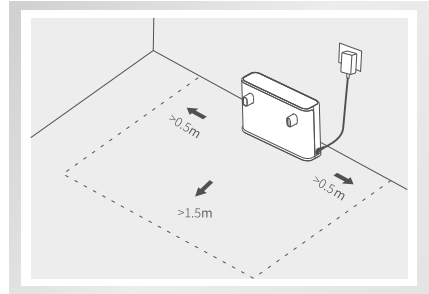

**2** Place the charging dock against a wall, and connect the power supply.

- Please ensure a space of at least 0.5m on both the left and right sides of the charging dock, and a space of at least 1.5m in front of it.
- Do not expose the charging dock to direct sunlight.

**3** Power on and charge

- Press “” and hold the button to turn on, wait for the indicator to be always on, and then lean the host against the charging dock to charge, and the language prompt "charging" indicates that charging has started.

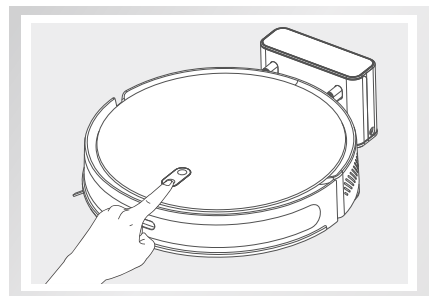

**Note:**

The battery is insufficient and cannot be turned on, please put the main unit on the charging dock, and the device will automatically power on.

## Product Operation

---

### Power on/off

- Press “⏻” and hold the button for 3 seconds, the indicator light will light up, and the power on will be successful.
- When the machine is standby, press “⏻” and hold the button for 3 seconds, the indicator light will be off, and the machine will be turned off.



**Note:**

The console cannot be powered off while it is charging.

### Sweep/Pause

- After the boot is completed, short press the upper button of the main machine, or the mobile App to start cleaning.



**Note:**

- Robot vacuums cannot be used to sweep liquids.
- If the battery level is less than 15%, you will not be able to perform the cleaning task, please charge it before continuing cleaning.
- When the battery level is lower than 15% during cleaning, the device will automatically return to the charging dock to recharge.
- Please tidy up all kinds of wires on the ground (including the power cord of the charging dock) before cleaning to avoid the power failure of electrical appliances and damage to items or wires caused by dragging the main unit during cleaning.

### Charging

- Automatic mode: After cleaning, the host will automatically return to the charging dock to charge.
- Manual mode: In the pause state, short press the button to start the recharge or the mobile App to start the recharge.



**Note:**

If the main unit does not find the charging cradle, it will automatically return to the starting position, please manually put the main unit back on the charging cradle to charge.

## Product Operation

---

### Automatic sweeping

After starting, the machine will first plan the cleaning path along the edge, and then plan the cleaning path in the way of bow-shaped filling, and clean the whole house in an orderly and efficient manner, and the device will automatically return to the charging dock for charging after the cleaning is completed (the default cleaning mode of the machine).

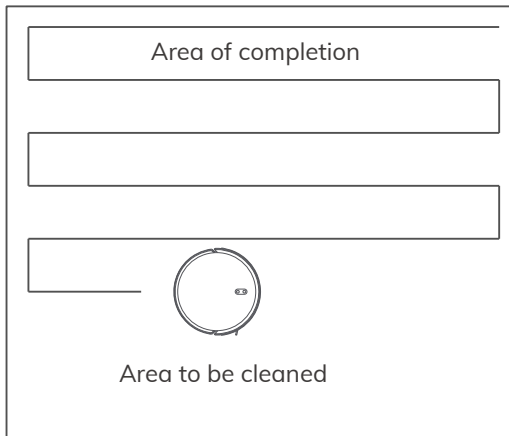

### Suction adjustment

Using the mobile App, you can choose Silent, Standard, Powerful, Max (MAX)

### Make an appointment for cleaning

The mobile App can be used to set a scheduled cleaning time.  
The console will automatically start cleaning at the specified time.



## App Download

1. Scan the QR code to install the App or search "ILIFE Clean" in the mobile App store to download the App.

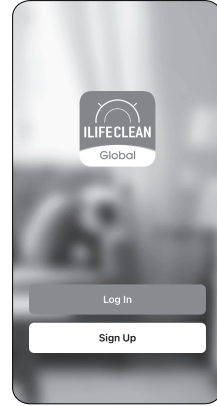

2. Register and log into the App.



3. At the same time, long press  and  for 3 seconds, and the voice prompt "WiFi has been reset" is heard. The white lights of the power button flash, and the robot enters the waiting state for connection. After the connection is completed, the white lights of the power button are steady on.

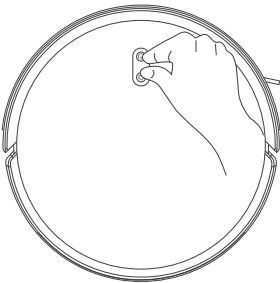

4. Click "Add a device" or "+" in the top right corner.

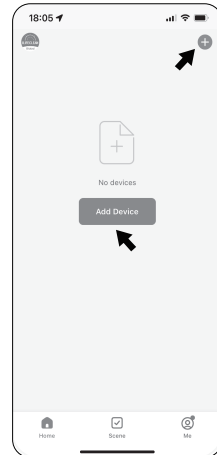

## App Download

### 5. Two methods available to add the device into the App.

#### Bluetooth ⇐

Enable Bluetooth on Your Phone:

To connect via Bluetooth, please ensure that Bluetooth is enabled on your phone.

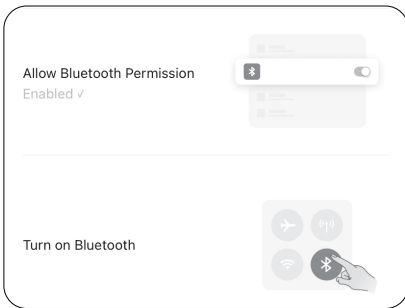

#### Pairing Process:

Go to setting in the phone and enable Bluetooth >

Back to App and the device will pop up on the top and click Add >

Select home 2.4GHz wifi and enter password > Download and finish.

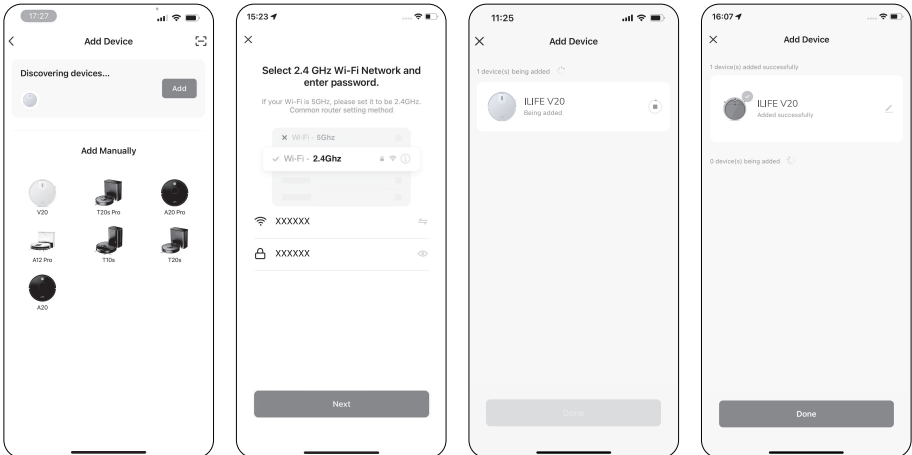



## App Download

### AP Mode ⇄

Select your device model.

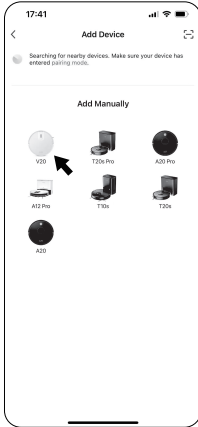

Select a 2.4GHz Wi-Fi network and enter the password.

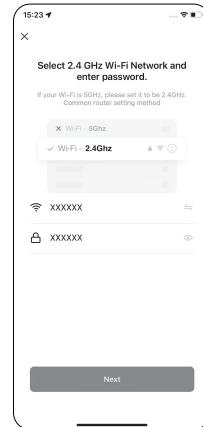

Go to phone's setting and select the robot's hotspot starting with "SmartLife", and after connecting successfully, return to the App.



Connecting device is processing. Please wait until finished.

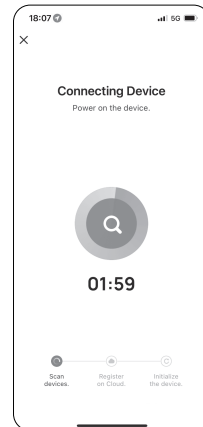

## App Download

---

### Connect with Amazon Alexa or Google Assistant

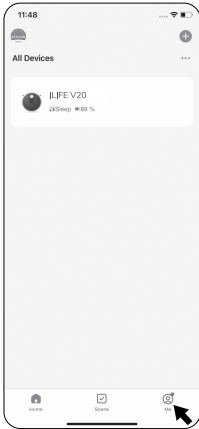

1. The robot vacuum cleaner connects to the App first. Click "Me" in the bottom right corner.

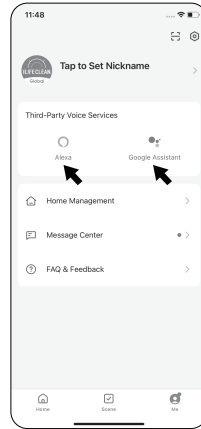

2. Click "Alexa" or "google Assistant" to enter the operation interface.

## Routine Maintenance

### Main brush (weekly cleaning recommended)

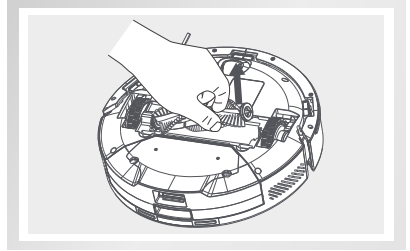
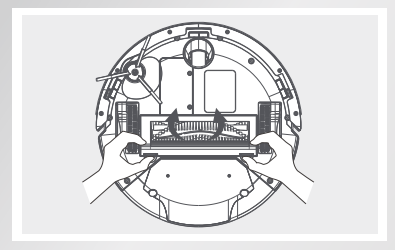

1 Flip the machine and hold down the buckle on the main brush cover and take out the main brush.

2 Remove the main brush.

3 Use the matching cleaning brush to sweep away the dust in the main brush and the main brush cavity, and then clean up the tangles on the main brush.

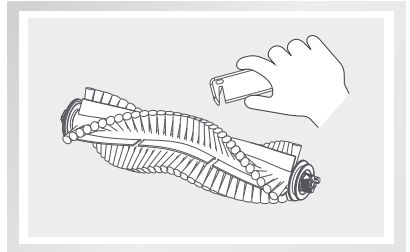

### Edge brush (weekly cleaning recommended)

1. Flip the machine and use a Phillips screwdriver to screw out the side brush screws and pull out the side brush.
2. Clean the tangled hairs and dirt and put it back on, and tighten the screws.

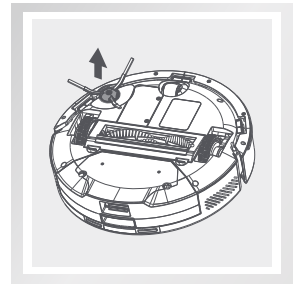

**Note:**

It is recommended to replace the side brush every 3 months to ensure the cleaning effect.

## Routine Maintenance

### Dustbin and filters (recommended after each cleaning)

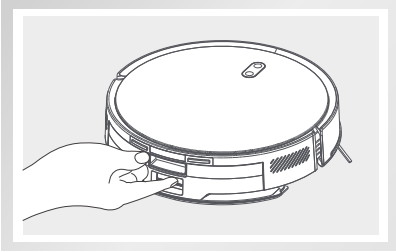

- 1 From the back of the machine, press and hold and take out the dustbin.

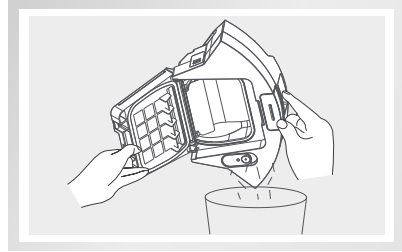

- 2 Press and hold the dustbin switch to open the dustbin and dump the garbage.

### Clean the dustbin (it is recommended to clean it once a week)

1. After a long period of use, remove the filter screen and HEPA filter
2. Put the removed primary filter screen and dustbin under the faucet to rinse (HEPA filter screen cannot be washed)
3. Dry the water droplets after cleaning, dry the filter screen and dustbin, and wait until it is completely dry before use.

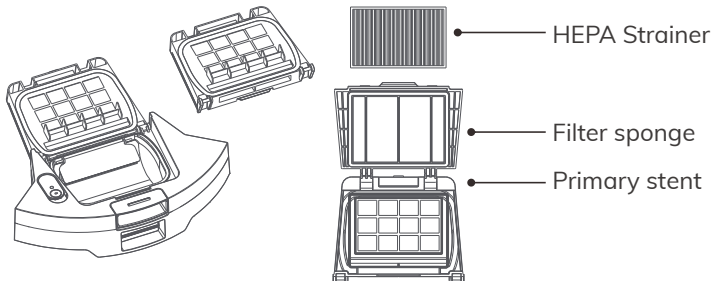

#### Note:

- Please rinse with clean water and do not add any detergent. Do not use brushes, fingers to clean the filter.
- Allow the strainer to dry thoroughly for at least 24 hours. It is recommended to replace one set of filters every 3 months.

## Routine Maintenance

### Water tank use

Do not use the mopping function on the carpet, after mopping the floor, please empty the water tank and remove the rag in time.

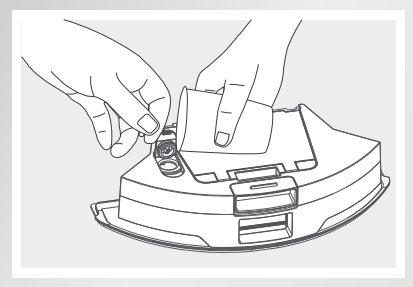

1 Add water

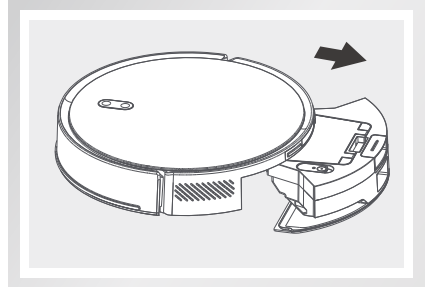

2 Install the tank assembly

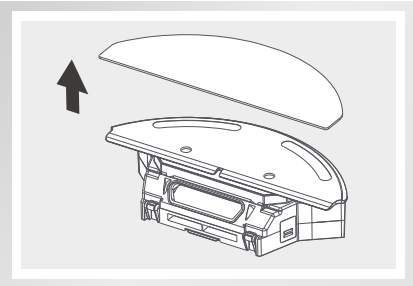

3 Install the rag

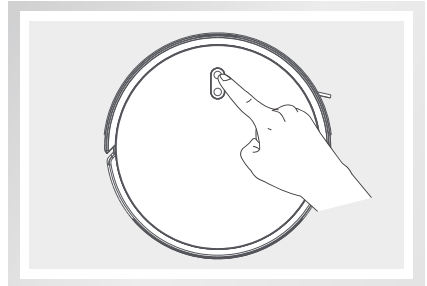

4 Start mopping

## Routine Maintenance

### Other spare parts

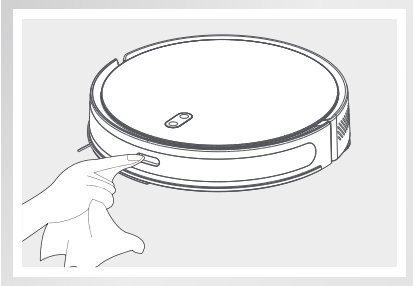

- 1 Cleaning spot laser detection sensor (monthly cleaning recommended)

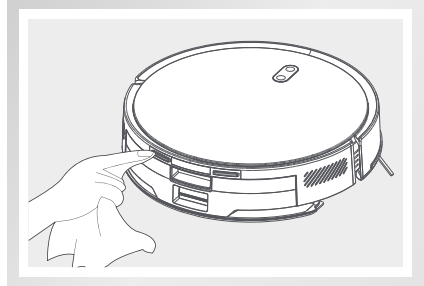

- 2 Clean the main unit charging contacts (it is recommended to clean them once a month)

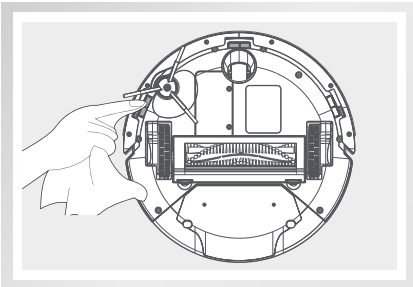

- 3 Cleanup cliff sensor (monthly cleaning is recommended)

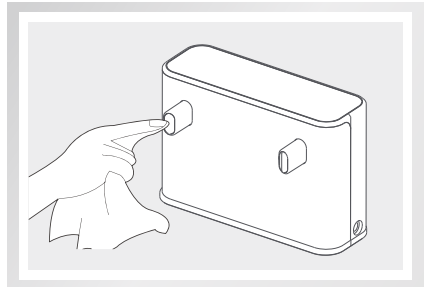

- 4 Clean the charging contacts of the charging dock (it is recommended to clean them once a month)

## Routine Maintenance

---

- 5 Clean the signal emission area of the charging dock (it is recommended to clean it once a month)

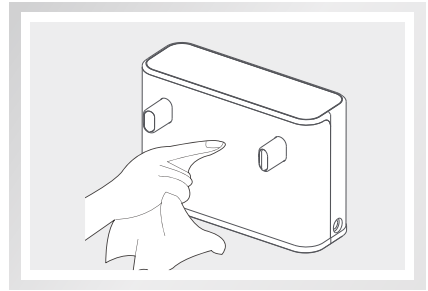

### Maintenance of the battery

1. The device has a built-in rechargeable lithium battery pack, in order to maintain the battery performance, please keep the host in a charged state for daily use, which is conducive to the best performance of the battery and does not consume excessive power.
2. If you are not in use for a long time, please fully charge: make sure to turn it off before storing.

## Normal questions

The type of question	Resolution
Crashed/Won't turn on	If the battery is low, place the device on the charging dock, align it with the contact point, and the device will automatically power on. If the ambient temperature is lower than 0°C, please use it in an environment of 0~40°C. Please check whether the power plug of the device is connected properly and confirm that the power supply to the socket is normal.
Unable to charge	If the contact is bad, please clean the dirt on the charging contact point, or unplug the side brush.
Cannot be recharged	If the device is too far away from the charging cradle, please place the main unit near the charging cradle and try it.
Abnormal behavior	There may be foreign objects entangled in the main brush, side brush or wheel, please clean it up after stopping.
Reduced cleaning ability or falling ash	The filter is clogged, please clean or replace it. The main brush is entangled by foreign objects, please clean the main brush.
Unable to connect to WiFi	The WiFi signal is not good, please make sure the device is in a good WiFi (2.4G frequency band, 5G does not support) signal coverage area. Please reset the WiFi and download the latest mobile App to try to connect again. Check if your password has been entered incorrectly.
Scheduled cleaning appointments are not valid	If the battery is insufficient, the remaining battery $\geq 15\%$ will start the scheduled cleaning.



## Product Specification

---

### Main unit

Product model	V20
Dimensions	330 x 330 x 83mm
Battery	Li-ion
Rated voltage	14.4V $\equiv$
Rated power	45W
Charging time	5H
Capacity of 2 in 1 water tank & dustbin	300ml + 250ml

### Charging dock

Dimensions	149.5 x 52 x 100mm
Rated inputs	20V $\equiv$ 0.6A
Rated outputs	20V $\equiv$ 0.6A

## Network Setup Steps:

- 1 Scan the QR code to download the app.



- 2 Register an account in the app.
- 3 Follow the app's network setup instructions for your specific device model.

### **Button Instructions**



#### **Power/Clean/Pause**

- Short press to start cleaning/pausing
- Long press 3 seconds to power on/off

#### **Recharge/Pause**

Press it to recharge/pause.

#### **Network Setup**

Press “” + “” and hold for 3 seconds, and you hear the voice prompt of “WIFI has been reset”.

